



It's all about trust:

QS01

QS03

QS00

QS20

QS30

QS40
Air

DS1

DS2

DS3

DS3.1

DS4

DS5

DS7

DS8

DS9

DNA

Cases

2020

Info

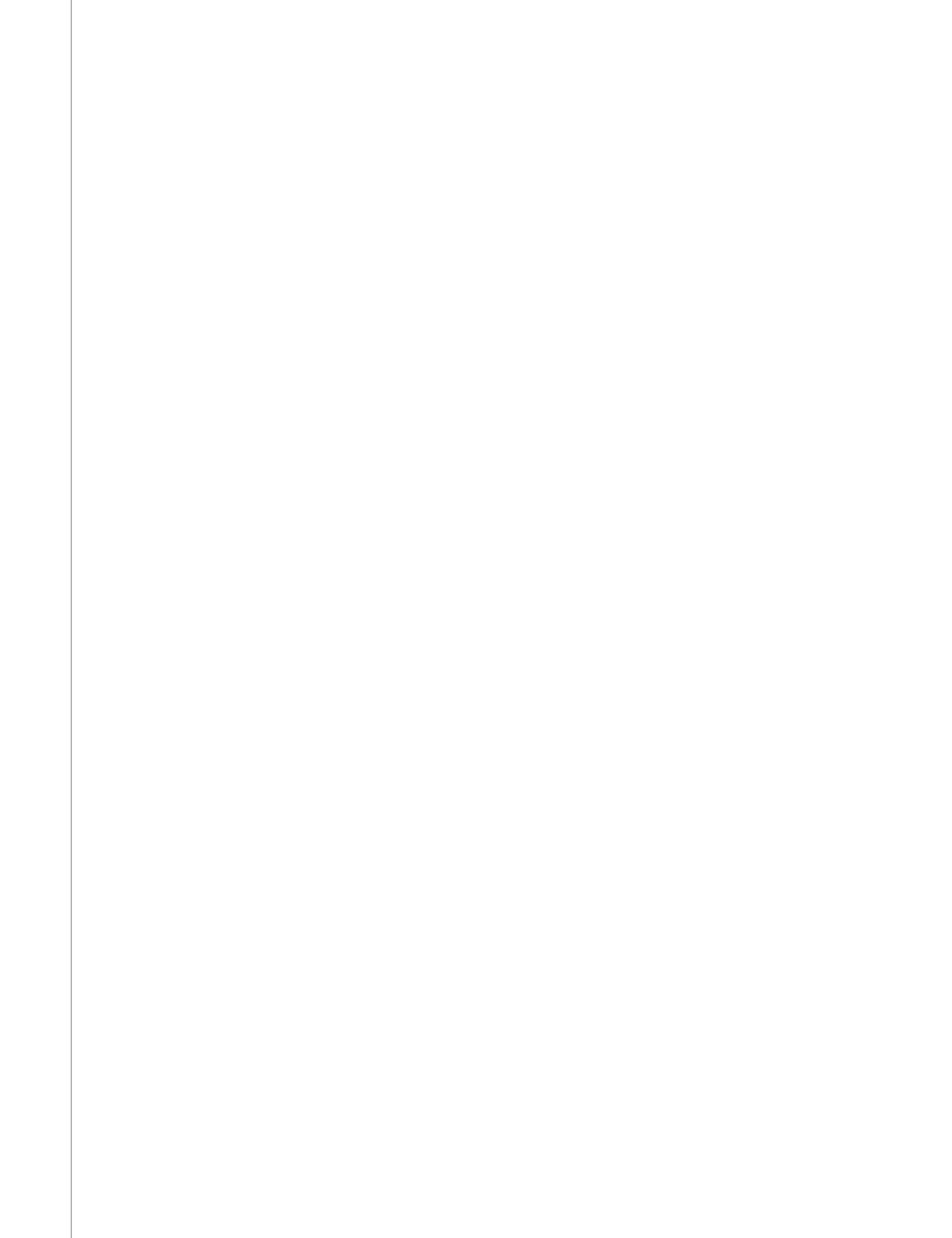

Contents

4-19	Novelties
20-69	QS Pens
70-149	DS Pens
150-159	DNA Identity Pen
160-165	PS Packaging and cases
168-171	Writing systems
172-177	Good to know
178	Special colours
179	Mix & Match
180-181	Fastlane
182-183	Colour and surface table

QS01

QS03

QS00

QS20

QS30

QS40
Air

DS1

DS2

DS3

DS3.1

DS4

DS5

DS7

DS8

DS9

DNA

Cases

Info

We manufacture all of our writing instruments in Switzerland: with passion and state-of-the-art technology – and in a design language that is timeless and clear, like the view from the Matterhorn by perfect weather.

[deu] **100% Swiss Made!**

Alle unsere Schreibgeräte fertigen wir in der Schweiz: mit Leidenschaft und modernster Technologie – und in einer Formensprache, die so zeitlos und klar ist wie der Blick vom Matterhorn bei schönstem Wetter.

[ita] **100% Swiss Made!**

Tutti i nostri strumenti di scrittura sono realizzati in Svizzera con passione, tecnologie all'avanguardia e un design intramontabile e nitido come la vista del Cervino con il cielo terso.

[fra] **100% Swiss Made !**

Tous nos instruments d'écriture sont fabriqués en Suisse : avec passion et une technologie de pointe – et dans un design aussi intemporel et clair que la vue du Cervin par beau temps.

[rus] **На 100 % сделано в Швейцарии!**

Все наши письменные приборы мы производим в Швейцарии: увлеченно и с использованием ультра-современных технологий и языка форм, который лишен отпечатка времени и так же ясен, как и вид с вершины Маттерхорн в самую прекрасную погоду.

[esp] **¡Hecho en Suiza al 100%!**

Fabricamos todos nuestros instrumentos de escritura en Suiza: con pasión y con la tecnología más avanzada. Y en un lenguaje de formas tan atemporal y diáfano como la silueta de nuestra emblemática cumbre – el Matterhorn – recortada en el cielo en un día despejado.

100%
Swiss Made!

100%
90
80
70
60
50
40
30
20
10
0



- QS01
- QS03
- QS00
- QS20
- QS30
- QS40
Air
- DS1
- DS2
- DS3
- DS3.1
- DS4
- DS5
- DS7
- DS8
- DS9
- DNA

Cases

Info

All of our writing instruments

**60%
less plastic**

**100%
more air!**

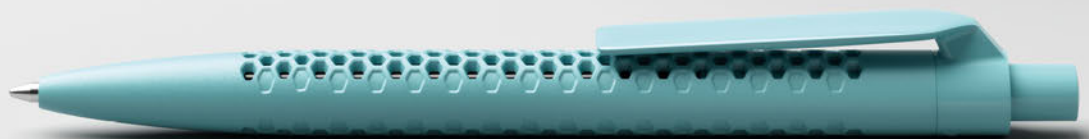
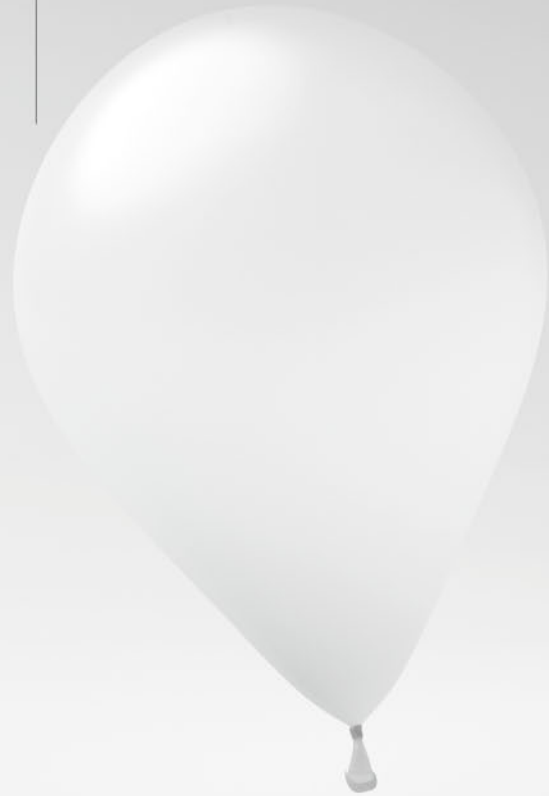

New QS40 Air

Although holes consist of nothing but air, they can have their own special charm, as the new QS40 proves. It is also why we named it, quite simply, «Air». For its production, we need up to 60% less plastic in comparison to other models. And when you consider that 30% of this plastic is recycled from our own production waste, that's a lofty achievement.

[deu] **60% weniger Kunststoff,
100% mehr Luft!**

Löcher bestehen zwar aus nichts als Luft, was aber seinen Reiz haben kann, wie der neue QS40 beweist, den wir deswegen «Air» genannt haben. Für seine Fertigung brauchen wir im Vergleich zu anderen Modellen bis zu 60% weniger Kunststoff. Und wenn man bedenkt, dass 30% dieses Kunststoffs aus Eigenabfällen recycelt werden, bleibt eigentlich kaum noch Luft nach oben.

[fra] **60% de plastique en moins,
100% plus d'air !**

Les trous ne sont rien d'autre que de l'air, mais cela peut avoir son charme, comme le prouve le nouveau QS40, que nous avons appelé «Air» pour cette raison. Pour sa production, nous utilisons jusqu'à 60% de plastique en moins par rapport aux autres modèles. Et si l'on considère que 30% de ce plastique est recyclé à partir de ses propres déchets, il n'est guère possible d'ajouter plus d'air.

[esp] **¡Un 60% menos de plástico,
un 100% más de aire!**

Algunos se dedican a hacer castillos en el aire, pero nosotros nos inspiramos en la ligereza del aire al diseñar el nuevo QS40, que denominamos «Air». Para fabricarlo, empleamos un 60% menos de plástico que en otros modelos. Y si consideramos que un 30% de este plástico proviene de residuos propios, podemos afirmar que con él llegamos a lo más alto.

[ita] **60% di plastica in meno,
100% di aria in più!**

I buchi sono fatti d'aria, che può avere il suo fascino come dimostra la nuova QS40, che proprio per questo abbiamo battezzato «Air». Per realizzarla, utilizziamo fino al 60% di plastica in meno a paragone con altri modelli. E se si pensa che il 30% di questa plastica viene riciclata a partire dai nostri scarti di produzione, resta a malapena ancora dell'aria.

[rus] **На 60 % меньше пластмассы,
на 100 % больше воздуха!**

Отверстия – это не что иное, как воздух, но и они могут иметь свое очарование. Это доказывает новая ручка QS40, которую мы назвали «Air» (воздух). Для ее изготовления нам требуется на 60 % меньше пластмассы по сравнению с другими моделями. А учитывая, что 30 % этой пластмассы производится из собственных отходов, желать большего – просто невозможно.

QS01

QS03

QS00

QS20

QS30

QS40
Air

DS1

DS2

DS3

DS3.1

DS4

DS5

DS7

DS8

DS9

DNA

Cases



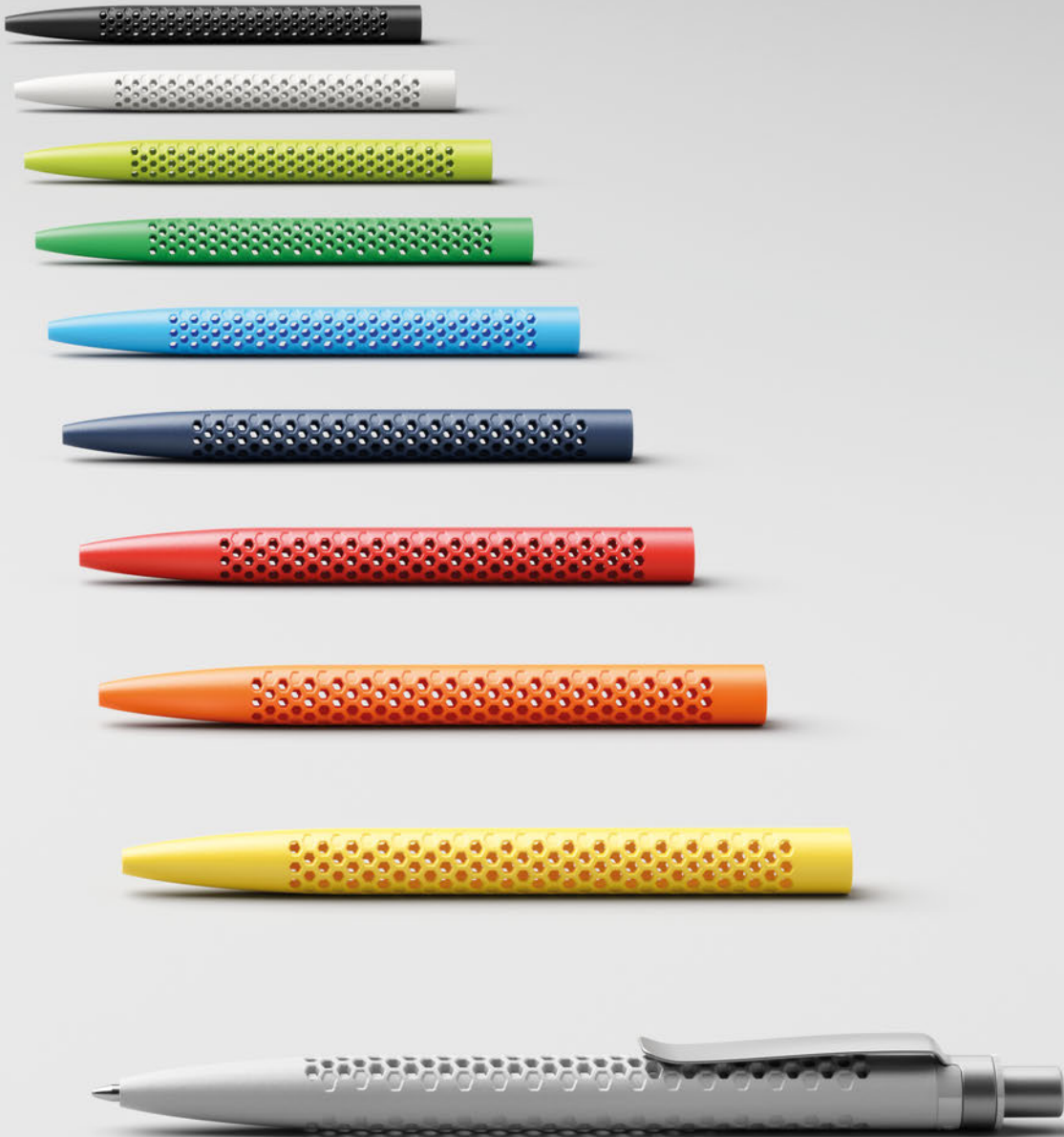

New QS40 Air

QS01

QS03

QS00

QS20

QS30

QS40
Air

DS1

DS2

DS3

DS3.1

DS4

DS5

DS7

DS8

DS9

DNA

Cases

Info

The three QS models which we now offer in the «Stone» version are manufactured from a special plastic substantially enhanced with minerals. This significantly reduces the use of plastic by 60%, while the weight of the writing instrument increases by a hefty 50%; this, in turn, significantly raises its value perception and additionally extends its service life. So, in the end, it's a win-win combination.

[deu] **60% weniger Kunststoff,
100% mehr Mineralien!**

Die drei QS Modelle, die wir Ihnen jetzt in der Ausführung «Stone» anbieten, fertigen wir aus einem besonderen, stark mit Mineralien angereicherten Kunststoff. Dadurch sinkt der Kunststoffverbrauch um deutliche 60%, während das Gewicht des Schreibgeräts um stattliche 50% zunimmt, was seine Wertwahrnehmung signifikant erhöht und seine Lebensdauer zusätzlich verlängert. So hängt am Ende alles mit allem zusammen.

[fra] **60% de plastique en moins,
100% de minéraux en plus !**

Les trois modèles QS, que nous vous proposons maintenant dans la version «Stone», sont fabriqués dans un plastique spécial à haute teneur en minéraux. Cela réduit la consommation de plastique de 60%, tandis que le poids de l'instrument d'écriture augmente de 50%, des valeurs significatives. Et cela augmente considérablement la perception de sa valeur et prolonge en plus sa durée de vie. Et, à la fin, tout s'accorde parfaitement.

[esp] **¡Un 60% menos de plástico,
un 100% más de minerales!**

Los tres modelos QS, que ahora le ofrecemos en la versión «Stone», están fabricados de un plástico especial, enriquecido con una alta proporción de minerales. De este modo, se reduce considerablemente – en un 60% – el consumo de plástico, mientras que aumenta el peso del instrumento de escritura en un 50%, lo que le confiere una imagen de más calidad y prolonga aún más su vida útil. Al fin y al cabo una cosa lleva a la otra.

[ita] **60% di plastica in meno,
100% di minerali in più!**

I tre modelli QS che vi offriamo ora in versione «Stone» sono realizzati in una particolare plastica arricchita di minerali. Questo riduce l'utilizzo di plastica di un buon 60%, aumentando del 50% il peso della penna: il risultato è che sembra più preziosa e dura anche di più. Alla fine tutto è collegato.

[rus] **На 60 % меньше пластмассы,
на 100 % больше минералов!**

Три модели QS, которые теперь мы предлагаем в исполнении «Stone», изготавливаются из специальной пластмассы, сильно обогащенной минералами. Благодаря этому расход пластмассы сокращается на 60 %, в то время как вес письменного прибора увеличивается на добрых 50 %, что существенно повышает его ценность и дополнительно продлевает срок службы. В конце концов, всё взаимосвязано.

60%
less plastic,

100%
more minerals!

100%
90
80
70
60
50
40
30
20
10
0



New QS Stone
Available for QS01, QS20 and QS30



QS01

QS03

QS00



QS20



QS30

QS40
Air

DS1

DS2

DS3

DS3.1

DS4

DS5

DS7

DS8

DS9

DNA

Cases

Info

30%
regenerated, at least!

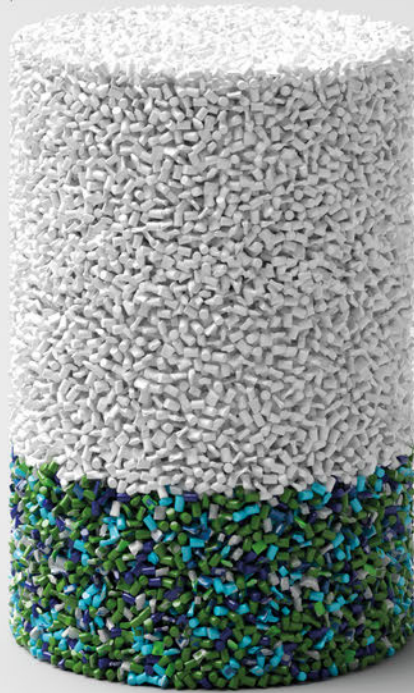

All of our writing instruments

All of our writing instruments are now made from 30% regenerated plastic. At least. Marie Kondo would have a tough time with us because we Swiss simply don't have the heart to throw away things that might still be useable.

[deu] **30% regeneriert, mindestens!**

Alle unsere Schreibgeräte bestehen jetzt zu 30% aus regeneriertem Kunststoff. Mindestens. Marie Kondo hätte es nicht leicht mit uns, denn wir Schweizer bringen es einfach nicht übers Herz, Dinge wegzuerwerfen, die man noch gebrauchen könnte.

[fra] **30% de régénération, au moins !**

Tous nos instruments d'écriture sont maintenant composés de 30% de plastique régénéré. Au moins. Marie Kondo n'aurait pas la tâche facile avec nous. Car nous, les Suisses, n'avons tout simplement pas le cœur à jeter ce que vous pourriez encore utiliser.

[esp] **Regenerados en un 30%, ¡como mínimo!**

Ahora todos nuestros instrumentos de escritura contienen un 30% de plástico regenerado. Como mínimo. Marie Kondo lo tendría difícil con nosotros, ya que los suizos no somos capaces de tirar objetos que aún se pueden utilizar.

[ita] **30% rigenerati, come minimo!**

Tutti i nostri strumenti di scrittura sono realizzati al 30% con plastica rigenerata. Come minimo. Marie Kondo non avrebbe vita facile con noi perché in Svizzera non ce la sentiamo di buttar via a cuor leggero cose che potrebbero ancora esserci utili.

[rus] **На 30 % переработанный материал, как минимум.**

Все наши письменные приборы теперь на 30 % состоят из переработанных отходов пластмасс. Как минимум. Мари Кондо было бы с нами непросто, ведь у нас, швейцарцев, рука не поднимется выбросить вещи, которые еще могут понадобиться.



QS01

QS03

QS00

QS20

QS30

QS40
Air

DS1

DS2

DS3

DS3.1

DS4

DS5

DS7

DS8

DS9

DNA

Cases

We now equip all of our writing instruments as standard with the Floating Ball® Lead Free refills, which are significantly less harmful to the environment. And the empty refills can of course be replaced in all models. After all, you wouldn't buy a car that couldn't be refilled or that only runs on leaded petrol.

[deu] **100% bleifrei!**

Alle unsere Schreibgeräte rüsten wir jetzt standardmäßig mit den deutlich schadstoffärmeren Floating Ball® Lead Free Minen aus. Und bei allen lassen sich verbrauchte Minen natürlich auswechseln. Schliesslich würden Sie auch kein Auto kaufen, das sich nicht nachtanken lässt oder nur mit bleihaltigem Benzin fährt.

[ita] **100% senza piombo!**

Tutti i nostri strumenti di scrittura sono ora dotati, nella versione standard, dei refill Floating Ball® Lead Free a basso impatto ambientale. E naturalmente, in tutti i modelli è possibile sostituire il refill esaurito. D'altra parte, chi comprerebbe un'auto che non si può rifornire di carburante o che si alimenta solo di benzina a base di piombo?

[fra] **100% sans plomb !**

Tous nos instruments d'écriture sont désormais équipés en série des recharges Floating Ball® Lead Free qui sont nettement moins nocives pour l'environnement. Et dans tous, les recharges usagées peuvent bien sûr être remplacées. Après tout, vous n'achèteriez pas une voiture où il serait impossible de refaire le plein ou qui fonctionne rait uniquement avec de l'essence au plomb.

[rus] **На 100 % без содержания свинца!**

Все наши письменные приборы теперь стандартно комплектуются стержнями Floating Ball® Lead Free с гораздо меньшим содержанием вредных веществ. И, естественно, во всех ручках использованные стержни можно заменить. В конце концов, вы же не стали бы покупать автомобиль, который не заправляется или ездит только на этилированном бензине.

[esp] **¡100% sin plomo!**

Ahora todos nuestros instrumentos de escritura están equipados de forma estándar con minas Floating Ball® Lead Free, que son más ecológicas. Y, por supuesto, en todos los modelos se pueden reemplazar las minas usadas. Al fin y al cabo, nadie compraría un automóvil que no se puede repostar o que solo circula con gasolina con plomo.

100%
lead-free!



- ▶ QS01
- ▶ QS03
- ▶ QS00
- ▶ QS20
- ▶ QS30
- ▶ QS40
Air
- ▶ DS1
- ▶ DS2
- ▶ DS3
- ▶ DS3.1
- ▶ DS4
- ▶ DS5
- ▶ DS7
- ▶ DS8
- ▶ DS9
- ▶ DNA

Cases

All of our writing instruments

Info

100%
regenerated!

— 100%
— 90
— 80
— 70
— 60
— 50
— 40
— 30
— 20
— 10
— 0



New DS Regeneration Pens

For the casings of our «Regeneration Pens», the proportion of recycled plastic is 100%. They are now available with a matt surface and in five beautiful colours. Including a new soft red and green, which are really greener than others, because we obtain them from cleanly separated and regenerated granulate without adding colour.

[deu] **100% regeneriert!**

Bei den Gehäusen unserer «Regeneration Pens» beträgt der Anteil recycelten Kunststoffes 100%. Es gibt sie jetzt neu in matter Oberfläche und in fünf natürlichen Farben. Darunter ein mildes Rot und ein sanftes Grün, die beide «grüner» ist als andere, weil wir sie ohne Zusatz von Farbe aus sauber separiertem und regeneriertem Granulat gewinnen.

[fra] **100% de régénération !**

Les boîtiers de nos stylos «Regeneration Pens», sont réalisés à 100 % en plastique recyclé. Ils sont maintenant disponibles en surface mate et en cinq couleurs naturelles. Dont un nouveau rouge et un nouveau vert, qui sont vraiment plus verts que les autres, parce qu’obtenus à partir de granulés soigneusement triés et régénérés, sans ajout de couleur.

[esp] **¡Regenerados al 100%!**

La proporción de plástico reciclado de las carcasas de nuestros «Regeneration Pens» es del 100%. Y ahora están disponibles con superficie mate y en cinco colores fuertes. De ellos destacan nuevos colores – rojo y verde suave – que son más verdes que el resto porque los producimos a partir de granulado regenerado, separado y limpio, sin pigmentos añadidos.

[ita] **100% rigenerate!**

Il corpo delle nostre «Regeneration Pens» si compone al 100% di plastica riciclata. I modelli sono ora disponibili in superficie opaca e in cinque colori naturali, tra cui un nuovo rosso e un nuovo verde che sono davvero più verdi degli altri perché sono ricavati, senza aggiunta di colore, da granulato finemente separato e rigenerato.

[rus] **На 100 % переработанный материал!**

Корпуса наших ручек «Regeneration Pens» на 100 % состоят из переработанных отходов пластмасс. Теперь они доступны с матовой поверхностью и в пяти эффектных расцветках. Среди них – новый нежно-зеленый цвет, который действительно зеленее, чем остальные, поскольку он добывается из чистого сепарированного и восстановленного гранулята без добавления краски.

QS01

QS03

QS00

QS20

QS30

QS40
Air

DS1

DS2

DS3

DS3.1

DS4

DS5

DS7

DS8

DS9

DNA

Cases

With all the tension that the world is currently confronting us with, a bit of rest is a blessing. Which is probably why our designers have chosen this rather gentle blue as the colour of the year 2020: Purist Blue, as mild as it is spirited, and available for all Prodir models already from 5.000 units.

[deu] **100% zeitgemäss!**

Bei all der Aufregung, die die Welt uns gegenwärtig beschert, tut uns ein bisschen Ruhe ganz gut. Wahrscheinlich haben unsere Designer deswegen dieses fast sanfte Blau zur Farbe des Jahres 2020 gewählt: Purist Blue, ebenso mild wie mutig und für alle Prodir Modelle schon ab 5'000 Stück.

[ita] **100% al passo con i tempi!**

Con tutta l'agitazione che il mondo ci procura, un po' di quiete non può farci che bene. Forse è per questo che i nostri designer hanno scelto questa delicata tonalità di blu come colore dell'anno 2020: Purist Blue, delicato e audace al tempo stesso, disponibile per tutti i modelli Prodir a partire da 5.000 pezzi.

[fra] **100% contemporain !**

Avec toute l'agitation que le monde nous apporte en ce moment, un peu de tranquillité nous fait du bien. C'est probablement la raison pour laquelle nos designers ont choisi ce bleu presque tendre comme couleur de l'année 2020 : Purist Blue, à la fois doux et audacieux, disponible pour tous les modèles Prodir, à partir de 5.000 pièces.

[rus] **На 100 % в духе времени!**

На фоне тех тревожных волнений, которыми полон современный мир, всем нам хочется немного покоя. Наверное, именно поэтому наши дизайнеры выбрали этот нежно-голубой оттенок цветом 2020 года: Purist Blue – мягкий и в то же время дерзкий, доступен для всех моделей Prodir как особый цвет уже от 5.000 штук.

[esp] **¡De actualidad, al 100%!**

Con todos los sobresaltos que conlleva el mundo actual, nos merecemos un poco de tranquilidad. Quizás este sea el motivo que ha inspirado a nuestros diseñadores al elegir este azul, más bien claro, como color del año 2020: el color Purist Blue aúna suavidad y decisión y está disponible en todos los modelos Prodir a partir de 5.000 unidades.

100%
contemporary!

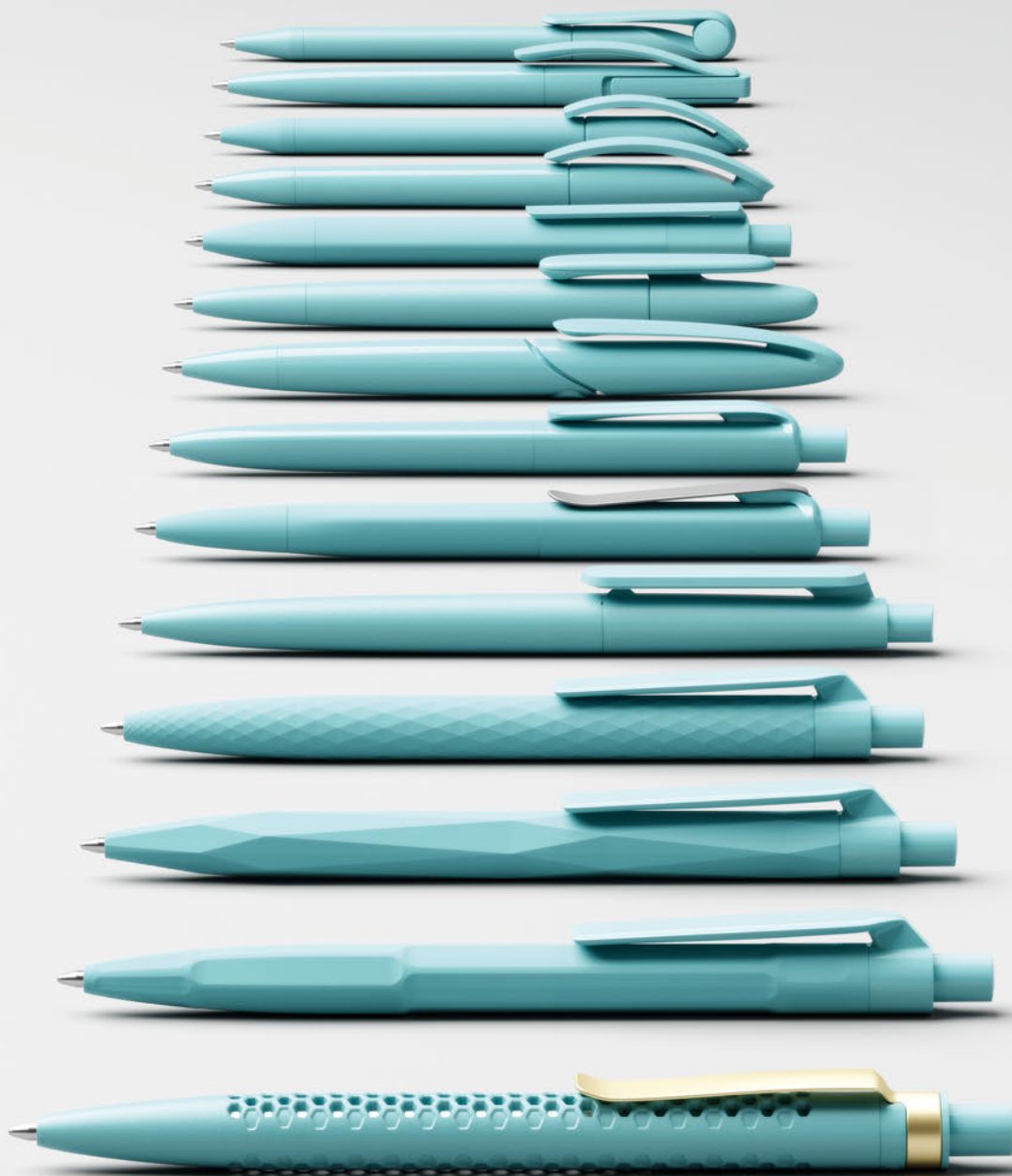

QS01



QS03



QS00



QS20



QS30



QS40
Air



DS1



DS2



DS3



DS3.1



DS4



DS5



DS7



DS8



DS9

DNA

Cases

Designer's choice 2020

Info

QS01

As multi-faceted as its surface: the QS01 has a fascinating rhythmically repeating triangular structure. The elegant 3D surface is injection moulded into the casing. Look and feel blend into a multi-sensory experience.

[deu] Er ist so facettenreich wie seine Oberfläche: Der QS01 fasziniert durch seine sich rhythmisch wiederholende Dreiecksstruktur. Die elegante 3D Oberfläche wird in einem Spezialverfahren in das Gehäuse eingebracht. Haptik und Optik verschmelzen zu einem multisensorischen Erlebnisraum.

[fra] Il présente autant de facettes que sa surface : le QS01 fascine par sa structure en triangles, qui se répète rythmiquement. La surface 3D élégante est appliquée au corps du stylo grâce à un procédé spécial de moulage par injection. Haptique et optique sont associées en un événement multisensoriel.

[esp] Es tan rico en matices como su superficie: el QS01 fascina por su estructura triangular, que se repite rítmicamente. La elegante superficie tridimensional se transfiere a la carcasa mediante un proceso especial de moldeado por inyección. Su háptica y su aspecto se funden en un espacio de experiencias multisensoriales.

[ita] È sfaccettata come la sua superficie: la QS01 affascina con la sua struttura triangolare che si ripete ritmicamente. L'elegante superficie 3D prende vita e si modella sul corpo della penna grazie ad uno speciale procedimento ad iniezione. Vista e tatto si fondono in un'esperienza multisensoriale.

[rus] Она так же многогранна, как и ее поверхность: QS01 завораживает своей структурой из множества ритмично повторяющихся треугольников. Элегантная трехмерная поверхность корпуса создается специальным способом литья под давлением. Слегка изогнутый клип демонстрирует логотип во всей красе. Внешний вид и тактильные ощущения превращают ее в источник самых разных чувственных переживаний.



The Promotional Gift
Award Winner



QS01

QS03

QS00

QS20

QS30

QS40
Air

DS1

DS2

DS3

DS3.1

DS4

DS5

DS7

DS8

DS9

DNA

Cases

QS01	P	M	T	-	S
------	---	---	---	---	---

- ①
- ②
- ③
- ④

① Writing system
P Push ball pen



② Body
M Matt
R Soft touch
Q Stone



③ Clip
T Transparent
P Polished
S Satin finish metal



④ Button
T Transparent
P Polished
S Satin finish metal
C Chrome finish metal

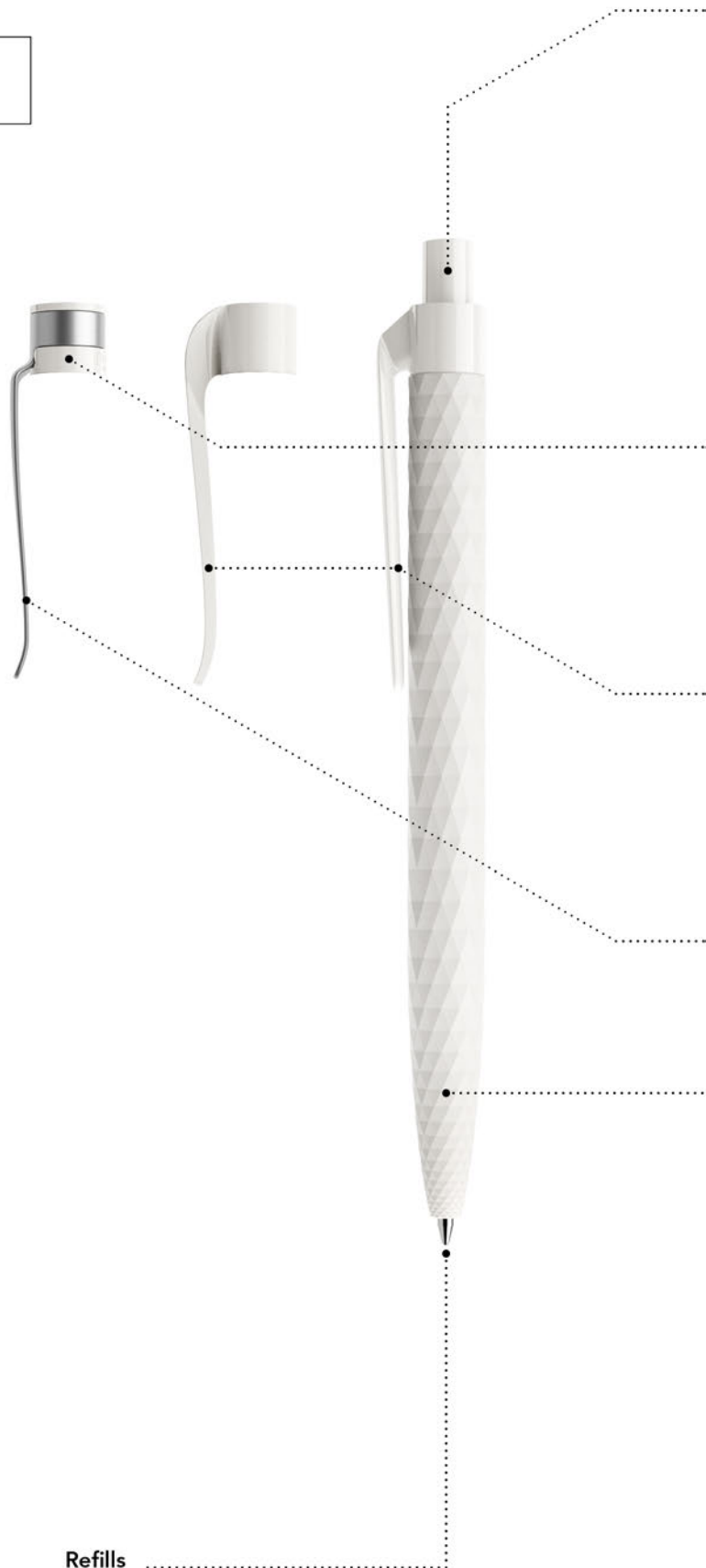

Refills

Standard Floating Ball® lead free 1.0 mm
All Prodir pens are refillable. Discover other options on page 168.

Button

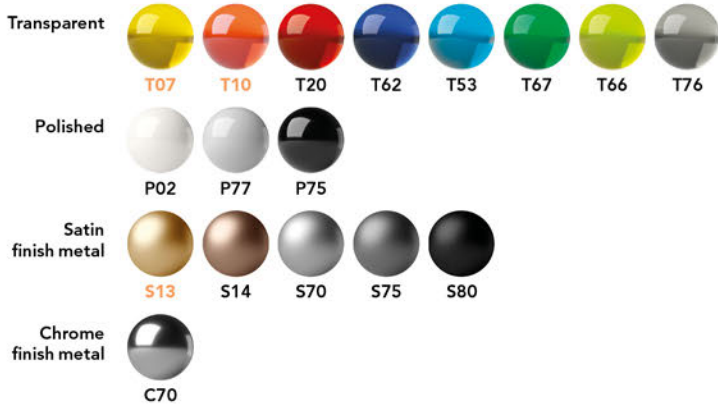

Clip holder (Only with metal clip)



Curved and flat plastic clip



Metal clip



Body



Designer's choice (Starting from 5.000 pieces)



New surface and colours!

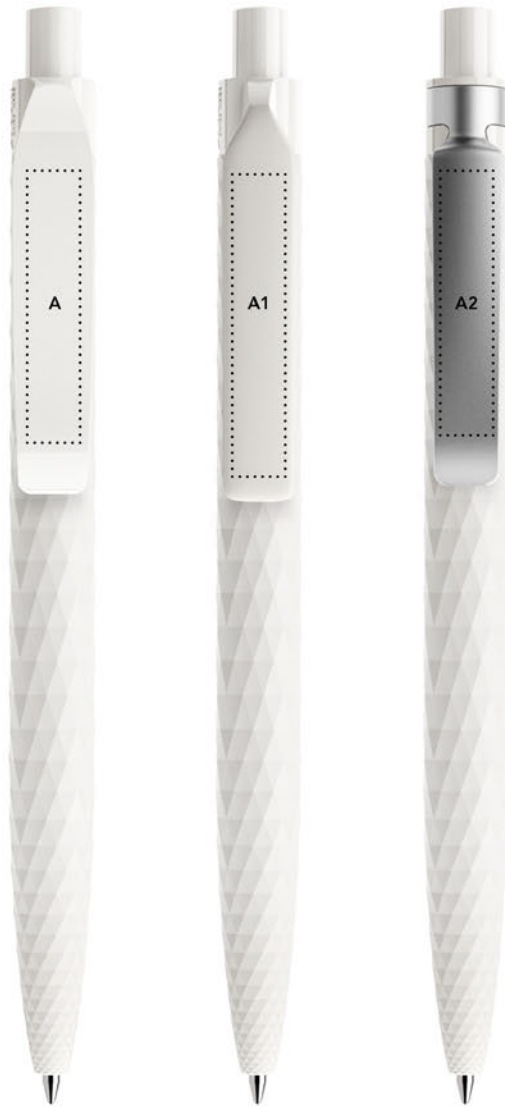

Print areas

		mm	Inch	Print	Notes
A	Curved clip	36 × 7	1,41 × 0,28	6 colours	-
A1	Flat clip	40 × 7	1,57 × 0,28	6 colours	-
A2	Metal clip	35 × 7	1,38 × 0,28	4 colours	Pad printing or laser engraving



Matt

QS01 PMP-P

Body	M02
Clip	P02
Button	P02

Matt

QS01 PMT-T

Body	M58
Clip	T53
Button	T53

Matt

QS01 PMT-T

Body	M20
Clip	T20
Button	T20

QS01

QS03

QS00

QS20

QS30

QS40
Air

DS1

DS2

DS3

DS3.1

DS4

DS5

DS7

DS8

DS9

DNA

Cases



Matt

QS01 PMS-T

Body	M07
Clip	S70
Clip holder	T07
Button	T07

Matt

QS01 PMP-P

Body	M67
Clip	P02
Button	P02

Soft touch

QS01 PRP-P

Body	R75
Clip	P75
Button	P75

New!



Stone

QS01 PQS-S

Body	Q75
Clip	S75
Clip holder	T62
Button	S75

New!

Stone

QS01 PQS-S

Body	Q62
Clip	S70
Clip holder	T76
Button	S70

New!

Stone

QS01 PQS-S

Body	Q13
Clip	S13
Clip holder	T76
Button	S13

New!

QS01

QS03

QS00

QS20

QS30

QS40
Air

DS1

DS2

DS3

DS3.1

DS4

DS5

DS7

DS8

DS9

DNA

Cases

QS03

It looks and feels like tyre tread: the visual and haptic perception creates a clear identity, and the Soft touch option conveys the message as an even more immediate sensory experience. The QS03 is a special interest model for companies working with cars, trucks and tyres and wanting people to literally grasp the message.

[deu] Er sieht aus wie ein Reifen und fühlt sich an wie ein Reifen: optische und haptische Wahrnehmung formen eine klare Identität, optionales Soft touch macht die Botschaft noch unmittelbarer sinnlich erfahrbar. Der QS03 ist ein Special-Interest-Modell für Unternehmen, die sich mit Autos und Reifen beschäftigen und das griffig kommunizieren wollen.

[fra] Il a l'apparence d'un pneu et son toucher est celui d'un pneu. La perception, optique et haptique, lui confère une identité claire, le revêtement Soft touch en option rend le message encore mieux perceptible par les sens. Le QS03 est un modèle particulièrement intéressant pour les entreprises qui sont en relation avec l'automobile, les véhicules commerciaux et les pneumatiques et qui souhaitent le faire savoir grâce au toucher.

[esp] Parece un neumático, y tiene el tacto de un neumático: la percepción óptica y háptica conforman una identidad clara, el Soft touch opcional hace que el mensaje se pueda experimentar de forma aún más inmediata con todos los sentidos. El QS03 es un modelo especialmente interesante para un sector: las empresas que estén relacionadas con los coches, los vehículos comerciales y los neumáticos y que deseen comunicarlo de forma palpable.

[ita] Ricorda uno pneumatico alla vista e al tatto: percezione tattile e visiva plasmano un'identità chiara, mentre con l'opzione Soft touch il messaggio raggiunge i sensi con maggiore immediatezza. La QS03 è un modello per un mercato specializzato, pensato per le aziende che si occupano di auto, veicoli commerciali e pneumatici e vogliono comunicarlo in modo tangibile.

[rus] Она выглядит как протектор, и воспринимается так же: визуальные и тактильные ощущения создают четкий образ, опциональная поверхность Soft Touch позволяет напрямую донести ваше чувственное послание до адресата. Ручка QS03 – это первая специализированная модель для предприятий, которые занимаются автомобилями и шинами и хотели бы оставить свой четкий след. QS03 демонстрирует возможности, которые открываются при трехмерном оформлении поверхности.



QS03

QS00

QS20

QS30

QS40
Air

DS1

DS2

DS3

DS3.1

DS4

DS5

DS7

DS8

DS9

DNA

Cases

Product code

QS03	P	M	P	-	P
------	---	---	---	---	---

- ① ② ③ ④

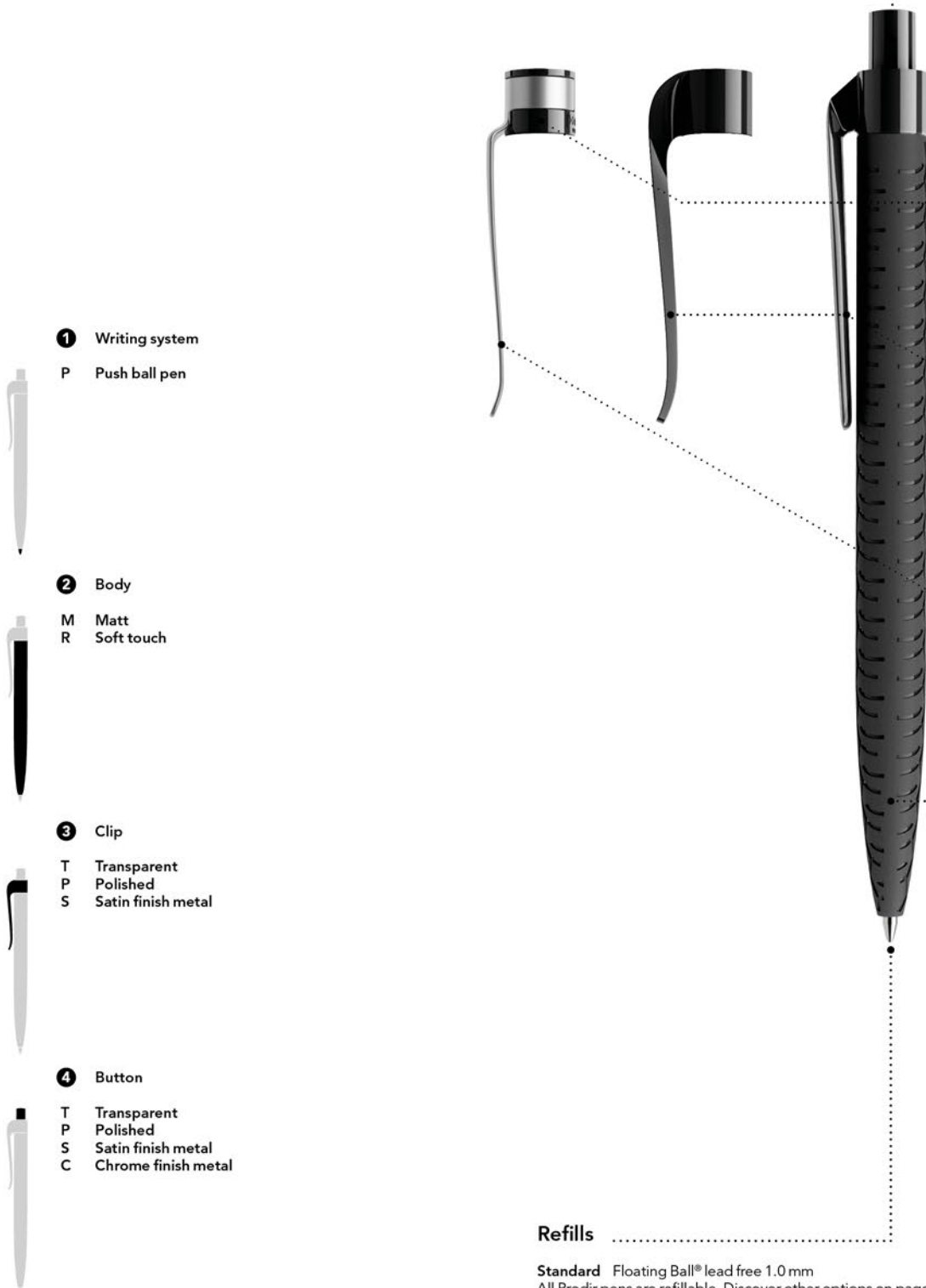

① Writing system

P Push ball pen



② Body

M Matt
R Soft touch



③ Clip

T Transparent
P Polished
S Satin finish metal



④ Button

T Transparent
P Polished
S Satin finish metal
C Chrome finish metal



Refills

Standard Floating Ball® lead free 1.0 mm
All Prodir pens are refillable. Discover other options on page 168.

Button

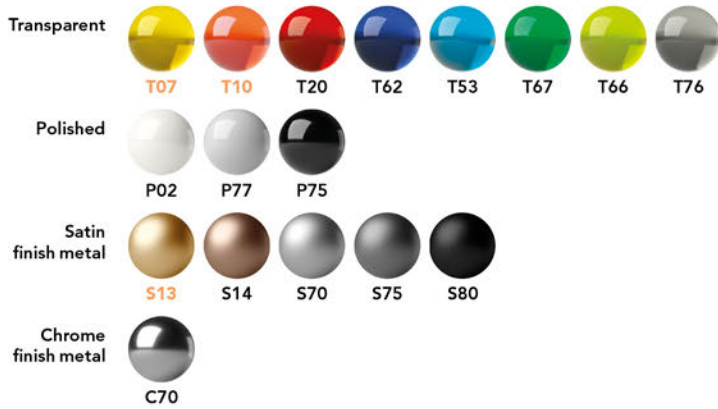

Clip holder (Only with metal clip)



Curved and flat plastic clip



Metal clip



Body



QS03

QS00

QS20

QS30

QS40
Air

DS1

DS2

DS3

DS3.1

DS4

DS5

DS7

DS8

DS9

DNA

Cases

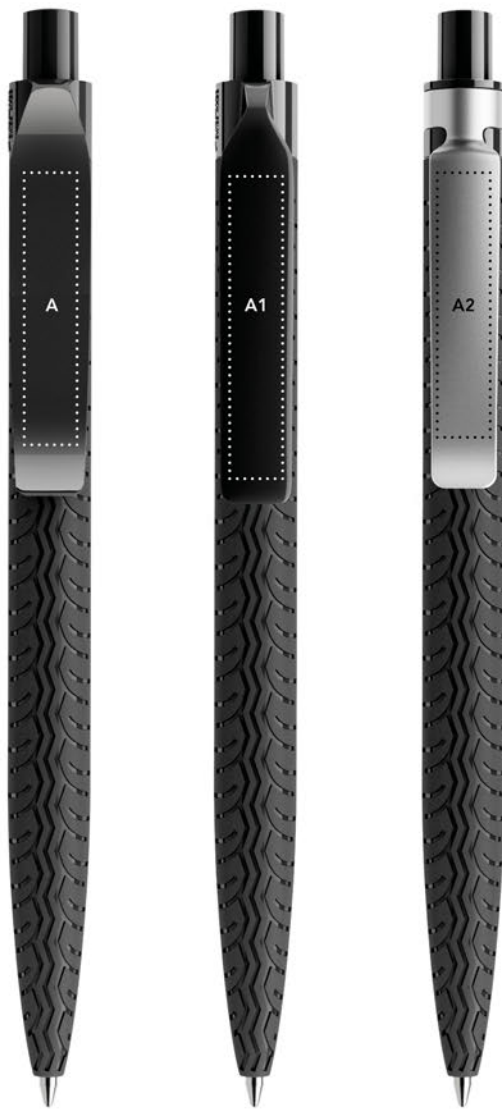

Print areas

		mm	Inch	Print	Notes
A	Curved clip	36 x 7	1,41 x 0,28	6 colours	-
A1	Flat clip	40 x 7	1,57 x 0,28	6 colours	-
A2	Metal clip	35 x 7	1,38 x 0,28	4 colours	Pad printing or laser engraving



Matt

QS03 PMP-P

Body	M75
Clip	P75
Button	P75

Matt

QS03 PMP-C

Body	M75
Clip	P75
Button	C70

Matt

QS03 PMP-P

Body	M75
Clip	P02
Button	P02

QS03

QS00

QS20

QS30

QS40
Air

DS1

DS2

DS3

DS3.1

DS4

DS5

DS7

DS8

DS9

DNA

Cases



Matt

QS03 PMT-T

Body	M75
Clip	T62
Button	T62

Soft touch

QS03 PRT-T

Body	R75
Clip	T66
Button	T66

Soft touch

QS03 PRP-C

Body	R75
Clip	P75
Button	C70



Soft touch

QS03 PRP-P

Body	R75
Clip	P77
Button	P77

Soft touch

QS03 PRP-S

Body	R75
Clip	P02
Button	S70

Soft touch

QS03 PRS-S

Body	R75
Clip	S80
Clip holder	P75
Button	S80

QS03

QS00

QS20

QS30

QS40
Air

DS1

DS2

DS3

DS3.1

DS4

DS5

DS7

DS8

DS9

DNA

Cases

QS00

The QS00 is a new dimension in personalization: features of your product or brand are injection moulded into the casing in the form of a unique and distinctive texture. This is only limited by what is technically feasible. The individual three-dimensional design of the surface allows for coherent brand communication from the product to the writing instrument as a sensory advertising medium.

[deu] Der QS00 steht für eine neue Dimension der Personalisierung: Merkmale Ihrer Produkt- oder Markenwelt werden im Spritzguss als Textur ins Gehäuse eingebracht, einzigartig und unverwechselbar. Grenzen setzt nur das technisch Machbare. Die individuelle dreidimensionale Gestaltung der Gehäuseoberfläche ermöglicht eine kohärente Markenkommunikation vom Produkt bis zum haptischen Werbeträger Schreibgerät.

[fra] Le QS00 représente une nouvelle dimension de la personnalisation : les caractéristiques de l'univers du produit ou de la marque sont associées au corps du stylo, en moulage par injection, de manière unique et inimitable. Les seules limites sont celles imposées par la technique. La configuration tridimensionnelle unique de la surface du corps de stylo permet une communication cohérente de la marque, du produit à l'instrument d'écriture avec son message promotionnel hépatique.

[esp] La QS00 representa una nueva dimensión de la personalización. Las características de su paleta de productos o del mundo de su marca se transfieren a la carcasa mediante moldeado por inyección, haciéndola única e inconfundible. Los únicos límites los pone la factibilidad técnica. El diseño tridimensional personalizado de la superficie de la carcasa permite una comunicación coherente de su marca, desde el producto hasta el bolígrafo como soporte publicitario háptico.

[ita] La QS00 rappresenta una nuova dimensione della personalizzazione: gli elementi tipici del tuo prodotto e del tuo marchio, tramite stampaggio ad iniezione, diventano parte integrante della struttura del corpo. Il risultato è unico e inconfondibile. Gli unici confini sono posti dalla fattibilità tecnica. Il disegno tridimensionale personalizzato della superficie permette di comunicare il marchio in modo completo e coerente, dal prodotto allo strumento di scrittura, generando un messaggio di comunicazione multisensoriale.

[rus] Ручка QS00 – это новое измерение в том, что касается персонализации: отличительные особенности вашей продукции или бренда наносятся на корпус методом литья под давлением в виде уникальной и неповторимой текстуры. Границы возможного определяются лишь технической осуществимостью. Индивидуальное трехмерное оформление поверхности корпуса обеспечивает целостное представление бренда, устанавливая непосредственную связь между тем или иным продуктом и тактильным носителем рекламы.



The Promotional Gift
Award Winner



PromoFritz
Award Winner

Create your own pattern!



QS00

QS20

QS30

QS40
Air

DS1

DS2

DS3

DS3.1

DS4

DS5

DS7

DS8

DS9

DNA

Cases

Product code

QS00	P	Z	Z	-	P
------	---	---	---	---	---

① ② ③ ④

Personalized 3D surface!

- ① Writing system
P Push ball pen



- ② Body
Z Matt
Z Matt + Polished
Z Soft touch



- ③ Clip
Z Transparent
Z Polished
Z Satin finish metal



- ④ Button
T Transparent
P Polished
S Satin finish metal
C Chrome finish metal

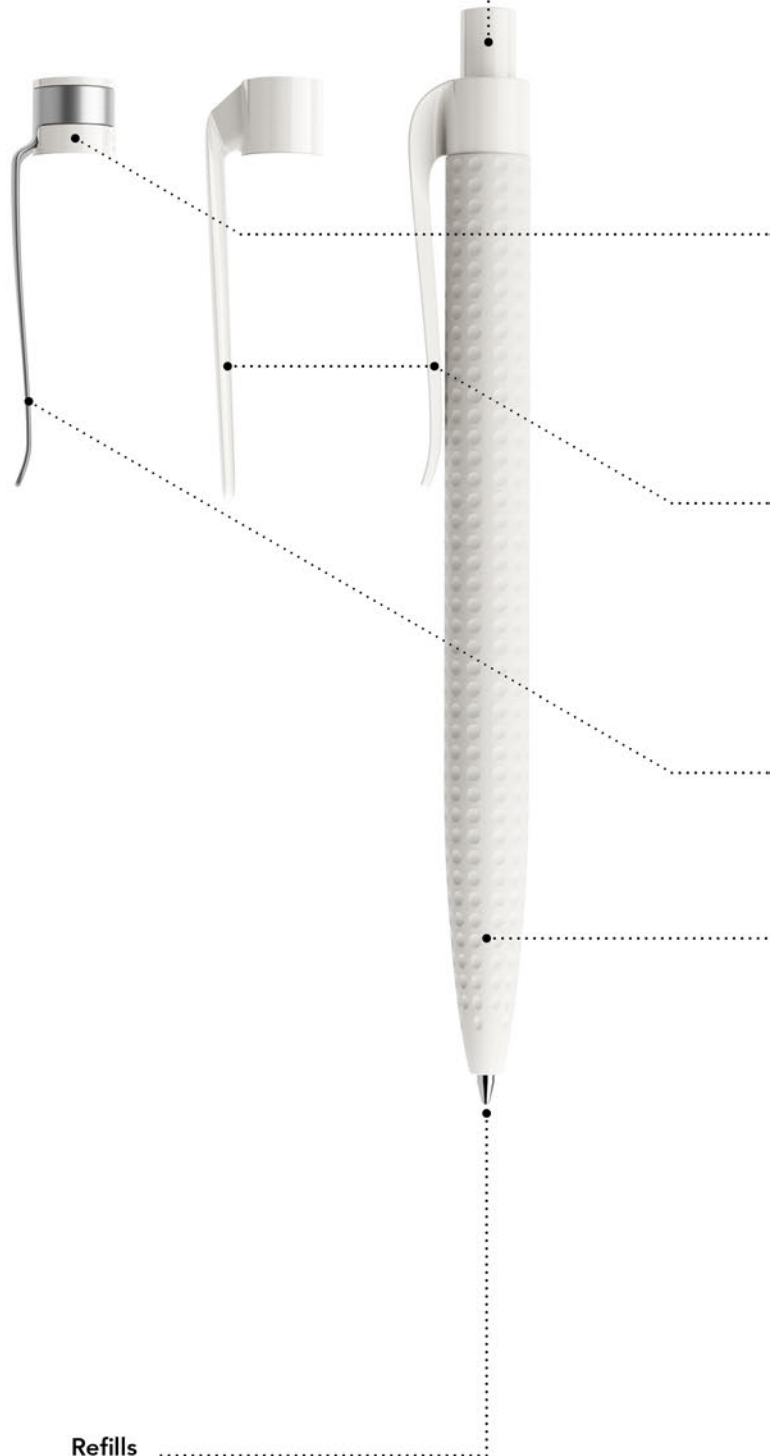

Refills

Standard Floating Ball® lead free 1.0 mm
All Prodir pens are refillable. Discover other options on page 168.

Button

Transparent



PMS

Polished



PMS

Satin
finish metal



S13

S14

S70

S75

S80

Chrome
finish metal



C70

Clip holder (Only with metal clip)

Transparent



PMS

Polished



PMS

Curved and flat plastic clip

Transparent



PMS

Polished



PMS

Metal clip

Satin
finish metal



S13

S14

S70

S75

S80

Body (Personalized 3D surface and colour)

Matt



PMS

Matt
+ Polished



PMS

Soft touch



PMS

QS00

QS20

QS30

QS40
Air

DS1

DS2

DS3

DS3.1

DS4

DS5

DS7

DS8

DS9

DNA

Cases

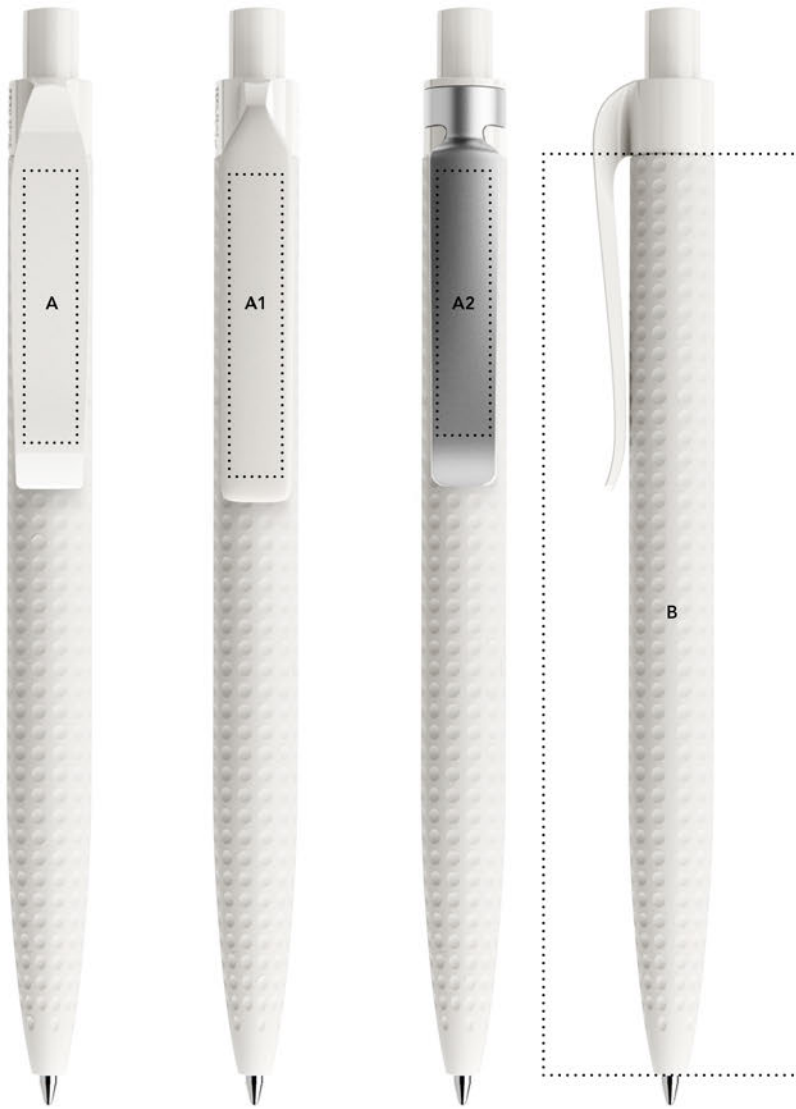

Print areas

		mm	Inch	Print	Notes
A	Curved clip	36 x 7	1,41 x 0,28	6 colours	-
A1	Flat clip	40 x 7	1,57 x 0,28	6 colours	-
A2	Metal clip	35 x 7	1,38 x 0,28	4 colours	Pad printing or laser engraving
B	Body	-	-	-	Personalized pattern

QS00

QS20

QS30

QS40
Air

DS1

DS2

DS3

DS3.1

DS4

DS5

DS7

DS8

DS9

DNA

Cases



Matt + Polished

QS00 PZZ-P

Body	Matt + Polished PMS
Clip	Polished PMS
Button	Polished PMS



Matt + Polished

QS00 PZZ-P

Body	Matt + Polished PMS
Clip	Polished PMS
Button	Polished PMS



Matt + Polished

QS00 PZZ-P

Body	Matt + Polished PMS
Clip	Polished PMS
Button	Polished PMS

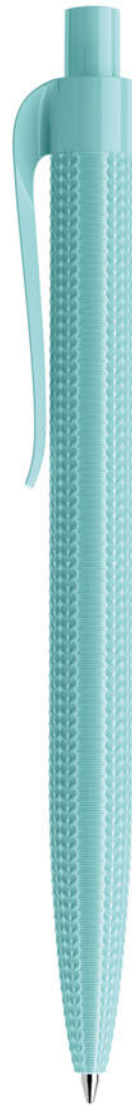

Matt + Polished

QS00 PZZ-P

Body	Matt + Polished PMS
Clip	Polished PMS
Button	Polished PMS



Matt + Polished

QS00 PZZ-P

Body	Matt + Polished PMS
Clip	Polished PMS
Button	Polished PMS



Matt + Polished

QS00 PZZ-P

Body	Matt + Polished PMS
Clip	Polished PMS
Button	Polished PMS



Matt + Polished

QS00 PZZ-P

Body	Matt + Polished PMS
Clip	Polished PMS
Button	Polished PMS



Matt

QS00 PZZ-P

Body	Matt PMS
Clip	Polished PMS
Button	Polished PMS



Matt

QS00 PZZ-S

Body	Matt PMS
Clip	Polished PMS
Button	S75

QS00

QS20

QS30

QS40
Air

DS1

DS2

DS3

DS3.1

DS4

DS5

DS7

DS8

DS9

DNA

Cases

QS20

The QS20 converts the principle of three-dimensional design of the casing surface into an object with sculptural effect. The look and feel are in perfect harmony, characterized by its bold form and perfect functionality.

[deu] Der QS20 überführt das Prinzip der dreidimensionalen Gestaltung der Gehäuseoberfläche in ein skulptural wirkendes Objekt. Optik und Haptik harmonisieren perfekt. Starke Form und perfekte Funktionalität zeichnen ihn aus.

[fra] Le QS20 traduit le concept de surface tridimensionnelle en un objet à l'allure de sculpture. Une harmonie parfaite s'établit entre optique et haptique. Une forme affirmée et une fonctionnalité parfaite distinguent ce modèle.

[esp] El QS20 interpreta el principio del diseño tridimensional de la superficie de la carcasa creando un objeto que parece una escultura. Su aspecto y su háptica armonizan a la perfección. Destaca por su potente forma y por su perfecta funcionalidad.

[ita] La QS20 trasferisce il principio della superficie tridimensionale in un oggetto che sembra una scultura. La vista e il tatto sono in perfetta armonia. La penna si contraddistingue per la sua forma originale e la perfetta funzionalità.

[rus] Принцип трехмерной конфигурации поверхности корпуса превращает ручку QS20 в скульптурный объект. Внешний вид и тактильные ощущения гармонично сочетаются между собой. Она отличается первоклассной формой и прекрасными функциональными возможностями.



The Promotional Gift
Award Winner



QS20

QS30

QS40
Air

DS1

DS2

DS3

DS3.1

DS4

DS5

DS7

DS8

DS9

DNA

Cases

Product code

QS20	P	M	P	-	P
------	---	---	---	---	---

① ② ③ ④

- ① Writing system
P Push ball pen



- ② Body
M Matt
R Soft touch
Q Stone



- ③ Clip
T Transparent
P Polished
S Satin finish metal



- ④ Button
T Transparent
P Polished
S Satin finish metal
C Chrome finish metal

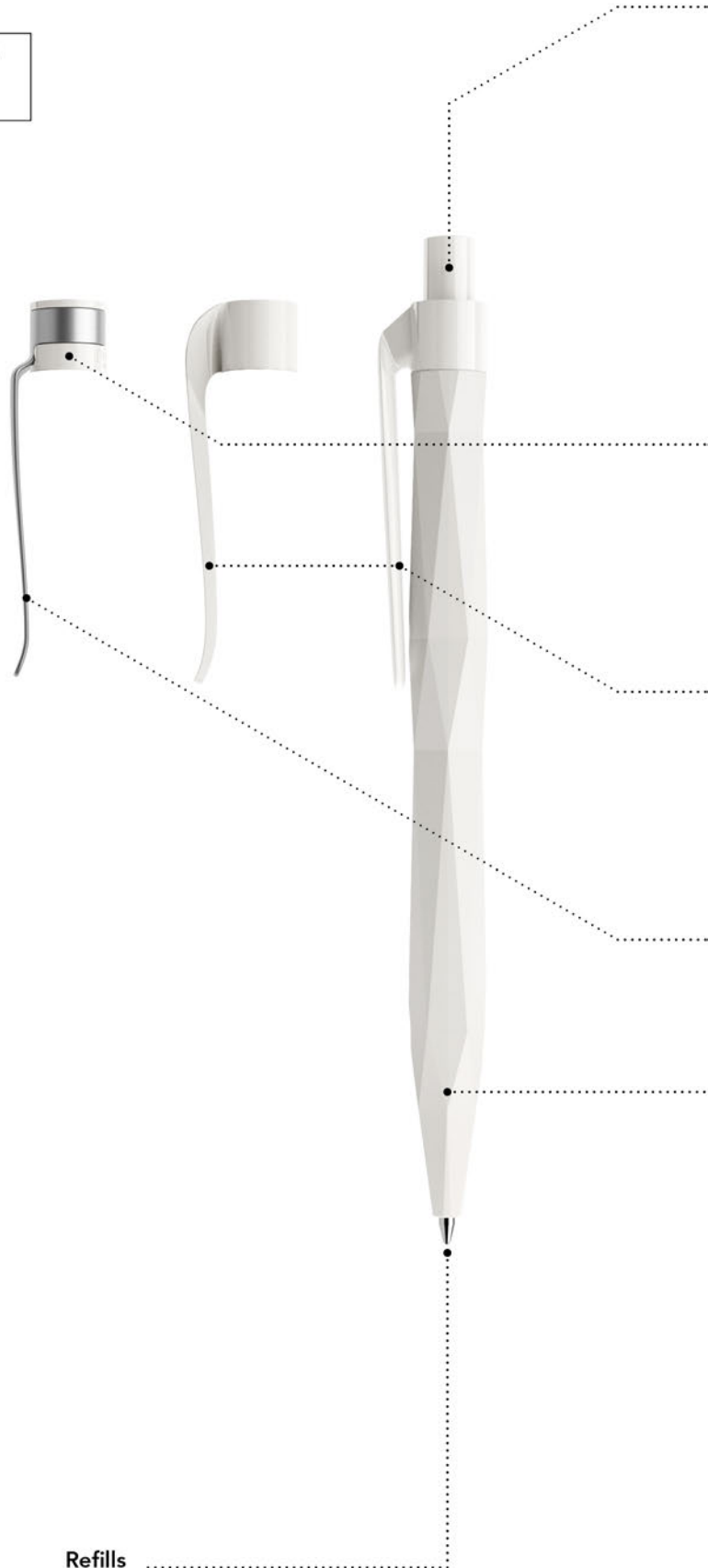

Refills

Standard Floating Ball® lead free 1.0 mm
All Prodir pens are refillable. Discover other options on page 168.

Button



Clip holder (Only with metal clip)



Curved and flat plastic clip



Metal clip



Body



Designer's choice (Starting from 5.000 pieces)



New surface and colours!

QS20

QS30

QS40
Air

DS1

DS2

DS3

DS3.1

DS4

DS5

DS7

DS8

DS9

DNA

Cases



Matt

QS20 PMP-P

Body	M75
Clip	P75
Button	P75

Matt

QS20 PMP-P

Body	M77
Clip	P77
Button	P77

Matt

QS20 PMT-T

Body	M10
Clip	T10
Button	T10

New!

QS20

QS30

QS40
Air

DS1

DS2

DS3

DS3.1

DS4

DS5

DS7

DS8

DS9

DNA

Cases



Soft touch

QS20 PRP-P

Body	R20
Clip	P02
Button	P02

Soft touch

QS20 PRT-T

Body	R62
Clip	T62
Button	T62



Soft touch

QS20 PRT-S

Body	Soft touch PMS
Clip	Transparent PMS
Button	S70



Stone

QS20 PQS-S

Body	Q75
Clip	S75
Clip holder	T76
Button	S75

New!

Stone

QS20 PQS-S

Body	Q13
Clip	S13
Clip holder	T76
Button	S13

New!

Stone

QS20 PQS-S

Body	Q02
Clip	S70
Clip holder	T76
Button	S70

New!

QS20

QS30

QS40
Air

DS1

DS2

DS3

DS3.1

DS4

DS5

DS7

DS8

DS9

DNA

Cases

QS30

The QS30 radiates the matter-of-factness of a good tool, upon which one can really rely. The finely-delineated three-dimensionally designed surface creates an optimal grip zone that melds elegantly with the classic form. The QS30 lies very comfortably in the hand; its weight is perfectly balanced.

[deu] Der QS30 strahlt die Selbstverständlichkeit eines guten Werkzeugs aus, auf das man sich verlassen kann. Die weichen Linien seiner dreidimensional gestalteten Oberfläche schaffen eine optimale Griffzone, die elegant mit der klassischen Form verschmilzt. Er liegt sehr angenehm in der Hand, sein Gewicht ist genau austariert.

[fra] Le QS30 rayonne l'évidence d'un bon outil sur lequel vous pouvez compter. Les lignes douces de sa surface tridimensionnelle créent une zone de préhension optimale qui s'harmonise élégamment avec la forme classique. Le nouveau QS30 incarne parfaitement l'outil fiable et précis.

[esp] El QS30 irradia la seguridad de un útil de calidad, en el que se puede confiar. Las superficies tridimensionales de líneas suaves configuran un área óptima de sujeción, que se funde elegantemente con las formas clásicas. En la mano, el QS30 se sostiene con mucha comodidad; tiene un peso perfecto.

[ita] La QS30 incarna l'essenzialità di uno strumento di lavoro preciso e affidabile. Le linee morbide della superficie tridimensionale creano un'impugnatura ottimale che si fonde elegantemente con la forma classica. Con il suo peso finemente calibrato, la QS30 è molto piacevole da tenere in mano.

[rus] Ручка QS30 со всей очевидностью заявляет о себе как о добротном инструменте, на который можно положиться. Формируемая плавными линиями трехмерная поверхность создает оптимальную зону контакта, которая элегантно перетекает в классическую форму. QS30 очень удобно лежит в руке, ее вес точно выверен.



QS30

QS40
Air

DS1

DS2

DS3

DS3.1

DS4

DS5

DS7

DS8

DS9

DNA

Cases

Product code

QS30	P	M	T	-	S
------	---	---	---	---	---

① ② ③ ④

① Writing system
P Push ball pen



② Body
M Matt
R Soft touch
Q Stone



③ Clip
T Transparent
P Polished
S Satin finish metal



④ Button
T Transparent
P Polished
S Satin finish metal
C Chrome finish metal

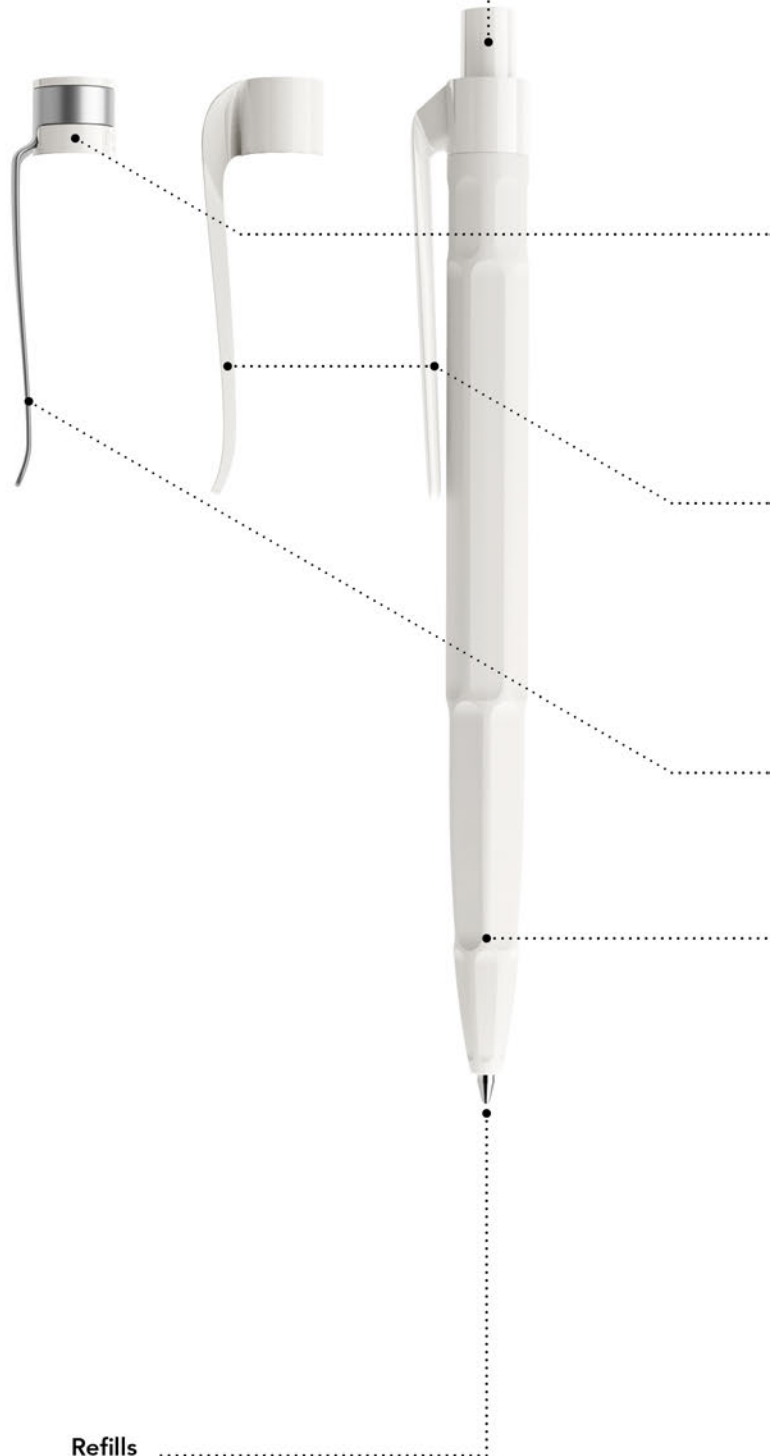

Refills

Standard Floating Ball® lead free 1.0 mm
All Prodir pens are refillable. Discover other options on page 168.

Button

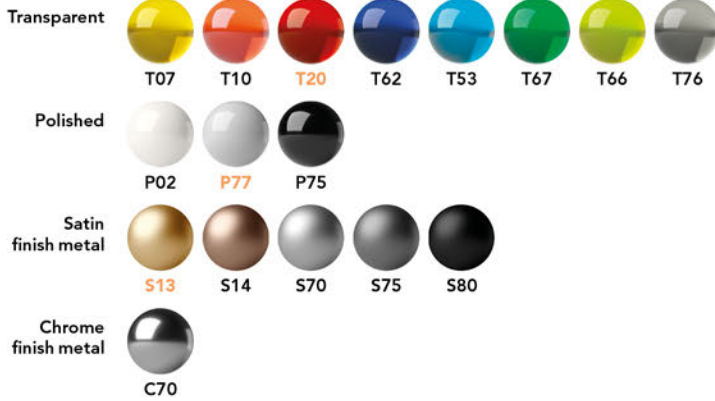

Clip holder (Only with metal clip)



Curved and flat plastic clip



Metal clip



Body

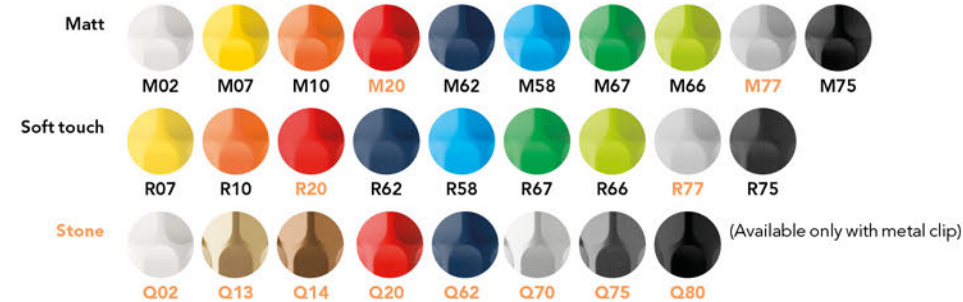

Designer's choice (Starting from 5.000 pieces)



New surface and colours!

QS30

QS40
Air

DS1

DS2

DS3

DS3.1

DS4

DS5

DS7

DS8

DS9

DNA

Cases



Print areas

		mm	Inch	Print	Notes
A	Curved clip	36 × 7	1,41 × 0,28	6 colours	-
A1	Flat clip	40 × 7	1,57 × 0,28	6 colours	-
A2	Metal clip	35 × 7	1,38 × 0,28	4 colours	Pad printing or laser engraving
B	Barrel	45 × 3	1,77 × 0,11	1 colour	Not available with metal clip



Matt

QS30 PMP-P

Body	M02
Clip	P02
Button	P02

Matt

QS30 PMT-P

Body	M20
Clip	T20
Button	P02

Matt

QS30 PMT-C

Body	M66
Clip	T66
Button	C70

New!

QS30

QS40
Air

DS1

DS2

DS3

DS3.1

DS4

DS5

DS7

DS8

DS9

DNA

Cases



Soft touch

QS30 PRP-P

Body	Soft touch PMS
Clip	Polished PMS
Button	Polished PMS

Soft touch

QS30 PRS-T

Body	R07
Clip	S70
Clip holder	T07
Button	T07

Soft touch

QS30 PRT-S

Body	R10
Clip	T10
Button	S80



Stone

QS30 PQS-5

Body	Q14
Clip	S14
Clip holder	T76
Button	S14

New!

Stone

QS30 PQS-5

Body	Q62
Clip	S70
Clip holder	T76
Button	S70

New!

Stone

QS30 PQS-5

Body	Q80
Clip	S80
Clip holder	T66
Button	S80

New!

QS30

QS40
Air

DS1

DS2

DS3

DS3.1

DS4

DS5

DS7

DS8

DS9

DNA

Cases

New QS40 Air

The new QS40 Air turns the three-dimensionality of its surface into a new aesthetic and sustainable form. The rhythmically perforated honeycomb structure provides a clear glimpse of the inner refill. Transparency, clarity and lightness are its defining features.

[deu] Der neue QS40 Air bringt die Dreidimensionalität seiner Oberfläche in eine neue, ebenso ästhetische wie nachhaltige Form. Die rhythmisch perforierte Wabenstruktur gibt den Blick frei auf die innenliegende Mine. Transparenz, Klarheit und Leichtigkeit zeichnen ihn aus.

[fra] Le nouveau QS40 Air transcrit la tridimensionnalité de sa surface dans une forme nouvelle, esthétique et durable. La structure rythmée en nid d'abeille, perforée, offre une vue dégagée sur la recharge à l'intérieur. Un design caractérisé par la transparence, la clarté et la légèreté.

[esp] El nuevo QS40 Air crea una forma novedosa y estética a partir del diseño tridimensional de su superficie. La estructura en panel, de diseño rítmico, concentra las miradas en la mina situada en el interior. Destaca por su transparencia, claridad y ligereza.

[ita] La nuova QS40 Air porta la superficie tridimensionale in una nuova linea al tempo stesso elegante e sostenibile. La struttura ritmica e perforata a nido d'ape permette di intravedere il refill all'interno. Una penna contraddistinta da trasparenza, leggerezza ed essenzialità.

[rus] Трехмерность поверхности новой ручки QS40 Air находит свое воплощение в новой форме, эстетичной и долговечной. Ритмичная структура сот позволяет рассмотреть расположенный внутри стержень. Прозрачность, ясность и легкость – вот отличительные черты этой ручки.



QS40
Air

DS1

DS2

DS3

DS3.1

DS4

DS5

DS7

DS8

DS9

DNA

Cases

Product code

QS40	P	M	T	-	S
------	---	---	---	---	---

① ② ③ ④

QS40
Air

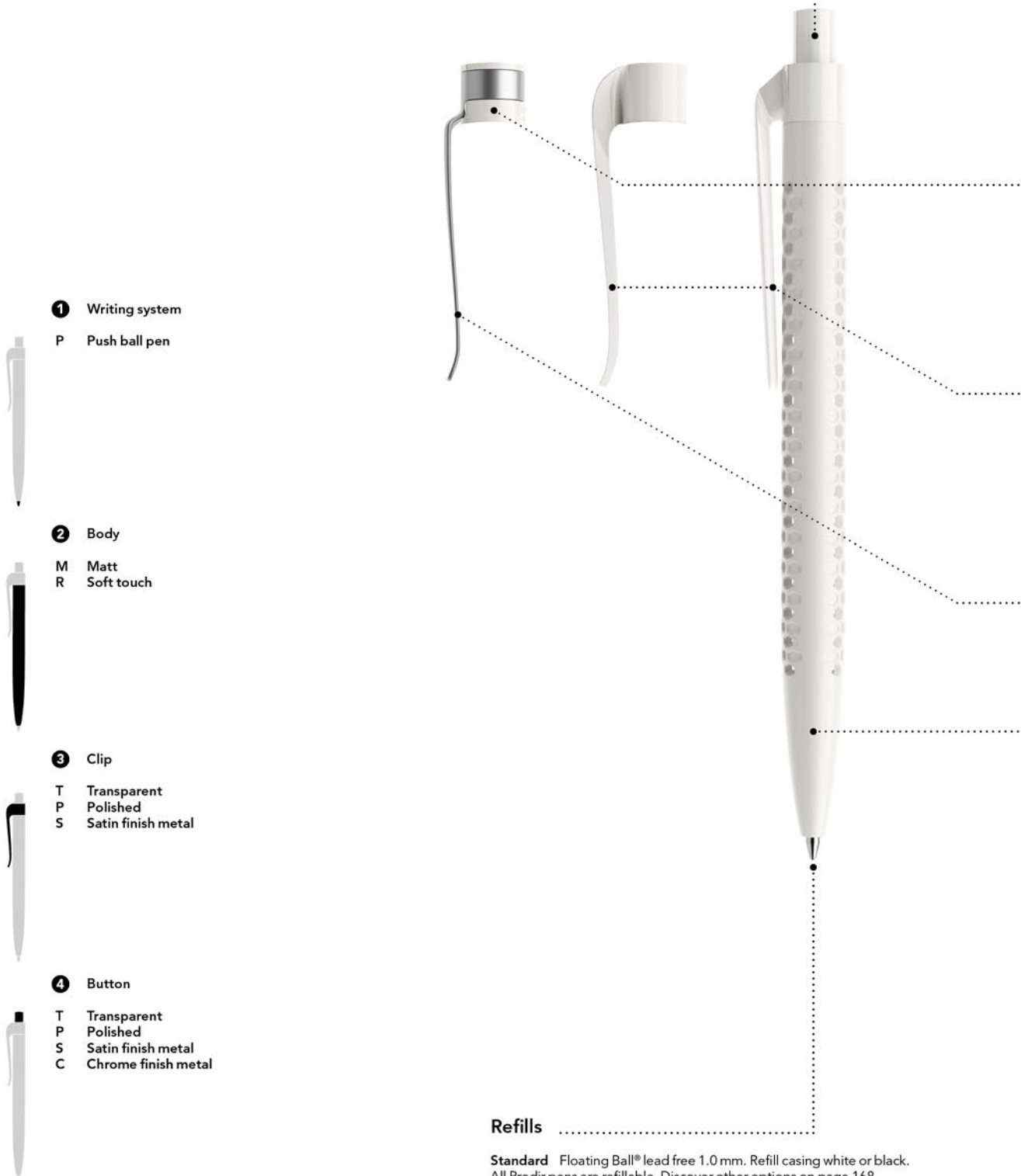

① Writing system

P Push ball pen



② Body

M Matt
R Soft touch



③ Clip

T Transparent
P Polished
S Satin finish metal



④ Button

T Transparent
P Polished
S Satin finish metal
C Chrome finish metal



Refills

Standard Floating Ball® lead free 1.0 mm. Refill casing white or black.
All Prodir pens are refillable. Discover other options on page 168.

Button



Clip holder (Only with metal clip)



Curved and flat plastic clip



Metal clip



Body



Designer's choice (Starting from 5.000 pieces)



QS40
Air

DS1

DS2

DS3

DS3.1

DS4

DS5

DS7

DS8

DS9

DNA

Cases

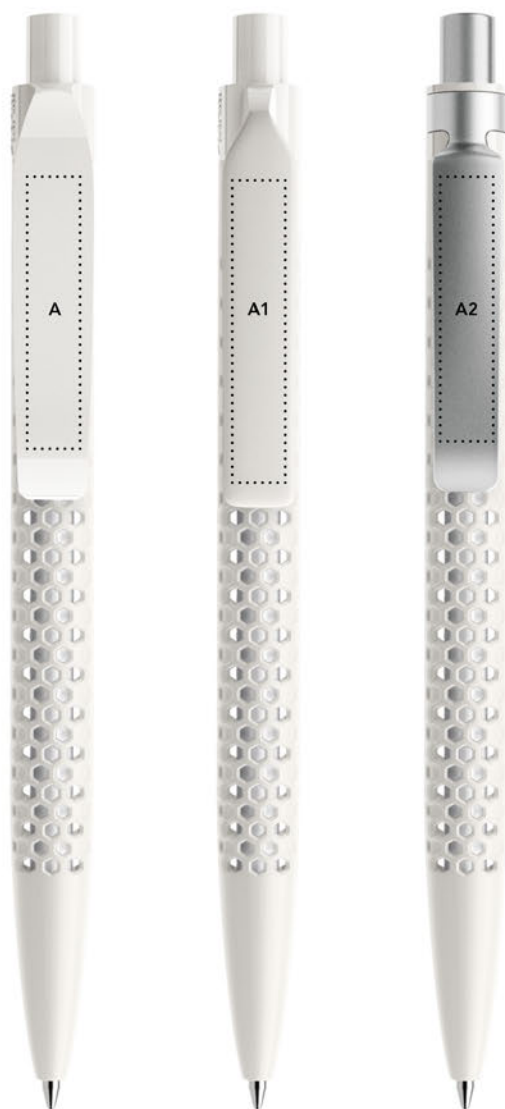

Print areas

		mm	Inch	Print	Notes
A	Curved clip	36 × 7	1,41 × 0,28	6 colours	-
A1	Flat clip	40 × 7	1,57 × 0,28	6 colours	-
A2	Metal clip	35 × 7	1,38 × 0,28	4 colours	Pad printing or laser engraving



Matt

QS40 PMP-P

Body	M02
Clip	P02
Button	P02

Matt

QS40 PMT-T

Body	M07
Clip	T07
Button	T07

Matt

QS40 PMT-T

Body	M10
Clip	T10
Button	T10

QS40
Air

DS1

DS2

DS3

DS3.1

DS4

DS5

DS7

DS8

DS9

DNA

Cases



Matt

QS40 PMT-T

Body	M20
Clip	T20
Button	T20

Matt

QS40 PMP-S

Body	M58
Clip	P02
Button	S70

Matt

QS40 PMS-P

Body	M37
Clip	S13
Clip holder	P37
Button	P37

Designer's choice



Matt

QS40 PMT-T

Body	M66
Clip	T66
Button	T66

Matt

QS40 PMT-T

Body	M67
Clip	T67
Button	T67

Matt

QS40 PMP-C

Body	M75
Clip	P75
Button	C70
Refill	Metal

QS40
Air

DS1

DS2

DS3

DS3.1

DS4

DS5

DS7

DS8

DS9

DNA

Cases



Soft touch

QS40 PRT-P

Body	R07
Clip	T07
Button	P75
Refill	Black

Soft touch

QS40 PRT-T

Body	R66
Clip	T66
Button	T66

Soft touch

QS40 PRT-T

Body	R20
Clip	T20
Button	T20



Soft touch

QS40 PRS-S

Body	R62
Clip	S70
Clip holder	T76
Button	S70

Soft touch

QS40 PRS-S

Body	R75
Clip	S80
Clip holder	T76
Button	S80
Refill	Black

Soft touch

QS40 PRP-P

Body	R77
Clip	P77
Button	P77

QS40
Air

DS1

DS2

DS3

DS3.1

DS4

DS5

DS7

DS8

DS9

DNA

Cases

DS1

With its slender body and beautifully designed cap that dynamically forms into the elegant clip, it is a design classic amongst ballpoint pens.

[deu] Mit seinem schlanken Gehäuse und der form-schönen Kappe, die schwungvoll in den eleganten Clip übergeht, ist er ein Klassiker des Schreibgeräte-Designs.

[fra] Avec son corps élancé, la ligne agréable de son capuchon, qui se termine par une agrafe élégante et dynamique, c'est un classique du design en matière de stylo.

[esp] Con su delgada carcasa y la bonita forma de su capuchón que se convierte de forma dinámica en el elegante clip, es todo un clásico del diseño de instrumentos de escritura.

[ita] Con il suo corpo snello e l'elegante cappuccio, che con la sua linea slanciata sfocia nella sinuosa clip, è un classico nel design degli strumenti di scrittura.

[rus] Благодаря изящному корпусу и колпачку красивой формы, плавно переходящему в элегантный клип, эта ручка представляет собой классический вариант дизайна письменных принадлежностей.



DS1

DS2

DS3

DS3.1

DS4

DS5

DS7

DS8

DS9

DNA

Cases

Product code

DS1	T	F	S	-	X
-----	---	---	---	---	---

① ② ③ ④

① Writing system

T Twist ball pen



② Cap and body

F Frosted
T Transparent
M Matt
P Polished



③ Nose cone

F Frosted
T Transparent
M Matt
P Polished
S Satin finish metal
C Chrome finish metal



④ Dot

X Polished



Refills

Standard Floating Ball® lead free 1.0 mm
All Prodir pens are refillable. Discover other options on page 168.

Dot option

Polished



Cap, body and nose cone

Frosted



Transparent



Matt



Polished



Metal nose cone

Satin finish metal



S70

Chrome finish metal



C70

Designer's choice (Starting from 5.000 pieces)

Cap, body and nose cone
Matt



M37

Dot option
Polished



X37

New surface and colours!

DS1

DS2

DS3

DS3.1

DS4

DS5

DS7

DS8

DS9

DNA

Cases

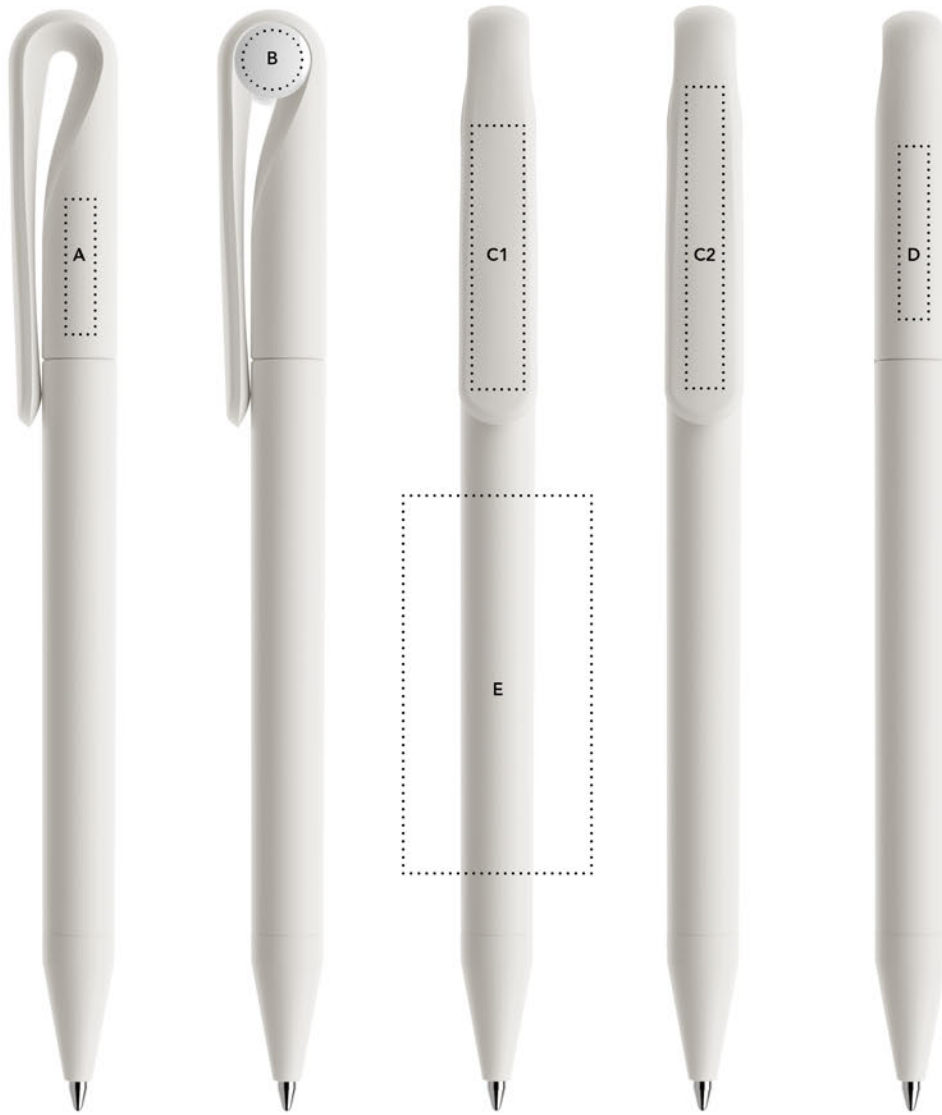

Print areas

		mm	Inch	Print	Note
A	Side cap	18 × 4	0,71 × 0,16	1 colour	-
B	Dot	8 × 8	0,31 × 0,31	5 colours	-
C1	Clip	35 × 7	1,38 × 0,28	5 colours	-
C2	Clip	40 × 5	1,57 × 0,20	5 colours	-
D	Back cap	23 × 4	0,90 × 0,16	1 colour	-
E	Body	50 × 25	1,97 × 0,98	4 colours	-



Frosted

DS1 TFF-X

Cap	F20
Body	F20
Nose cone	F20
Dot	X20

Transparent

DS1 TTC

Cap	T10
Body	T10
Nose cone	C70

Transparent

DS1 TTT-X

Cap	T55
Body	T55
Nose cone	T55
Dot	X01

DS1

DS2

DS3

DS3.1

DS4

DS5

DS7

DS8

DS9

DNA

Cases



Matt

DS1 TMM-X

Cap	M02
Body	M02
Nose cone	M02
Dot	X75

Matt

DS1 TMM

Cap	M49
Body	M49
Nose cone	M49

Matt

DS1 TMS-X

Cap	M75
Body	M75
Nose cone	S70
Dot	X01



Polished

DS1 TPP

Cap P52
 Body P52
 Nose cone P52

Polished

DS1 TPP-X

Cap Polished PMS
 Body Polished PMS
 Nose cone Polished PMS
 Dot X01

Polished

DS1 TPP

Cap P02
 Body P02
 Nose cone P02

DS1

DS2

DS3

DS3.1

DS4

DS5

DS7

DS8

DS9

DNA

Cases

DS2

The elongated push button provides its very individual contour. As always with Prodir, the walls of the components have been designed to maximum thickness. That ensures intensively vivid colours and comfortable weight in the hand.

[deu] Der lang gestreckte Druckknopf verleiht ihm seine ganz individuelle Linie. Wie immer bei Prodir sind die Wände der Bauteile auf maximale Stärke ausgelegt. Das sorgt für intensiv leuchtende Farben und angenehme Schwere in der Hand.

[fra] Le bouton poussoir allongé lui confère une ligne bien particulière. Comme toujours chez Prodir, les différents éléments bénéficient d'une épaisseur maximale. C'est le gage de couleurs intenses et vives et d'un poids agréable dans la main.

[esp] El botón de presión alargado le aporta una línea completamente individual. Como en todos los productos de Prodir, las paredes de los componentes están diseñadas con el máximo espesor. Gracias a ello, se consiguen colores con un brillo intenso, y un peso agradable al empuñarlos.

[ita] Il pulsante esile e slanciato caratterizza questa penna dalla linea unica. Come sempre Prodir ha realizzato i componenti con il massimo spessore possibile per offrire colori intensi e vivaci ed un peso confortevole in mano.

[rus] Вытянутая в длину нажимная кнопка придает ей неповторимую индивидуальность. Как это принято у Prodir, стенки деталей рассчитаны на максимальную толщину. Это обеспечивает насыщенность цветов и приятную увесистость.



The Promotional Gift
Award Winner



DS2

DS3

DS3.1

DS4

DS5

DS7

DS8

DS9

DNA

Cases

Product code

DS2	P	F	S	-	F
-----	---	---	---	---	---

① ② ③ ④

① Writing system

P Push ball pen



② Cap

F Frosted
T Transparent
M Matt
P Polished



② Cap and body

F Frosted
T Transparent
M Matt
P Polished



③ Barrel

F Frosted
T Transparent
M Matt
P Polished



③ Nose cone

S Satin finish metal
C Chrome finish metal



④ Button

F Frosted
T Transparent
M Matt
P Polished

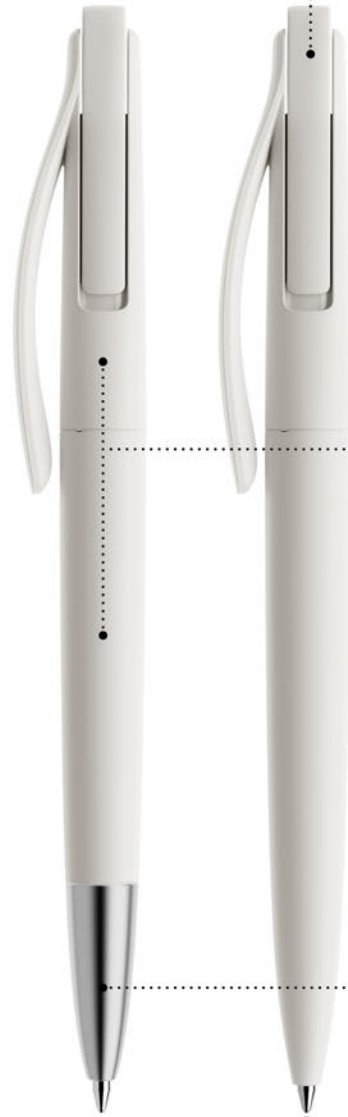

Refills

Standard Floating Ball® lead free 1.0 mm
All Prodir pens are refillable. Discover other options on page 168.

Button

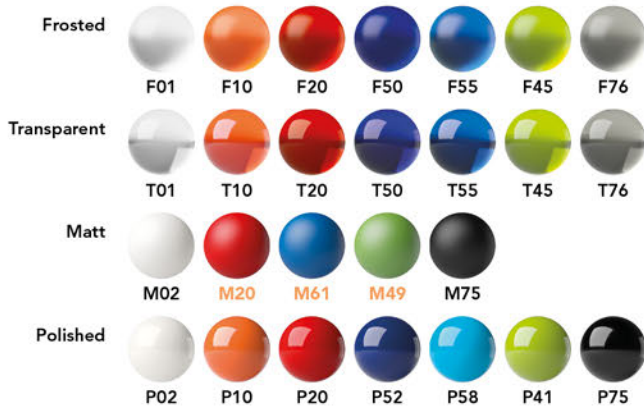

Cap, body and barrel



Metal nose cone



Designer's choice (Starting from 5.000 pieces)



New surface and colours!

DS2

DS3

DS3.1

DS4

DS5

DS7

DS8

DS9

DNA

Cases

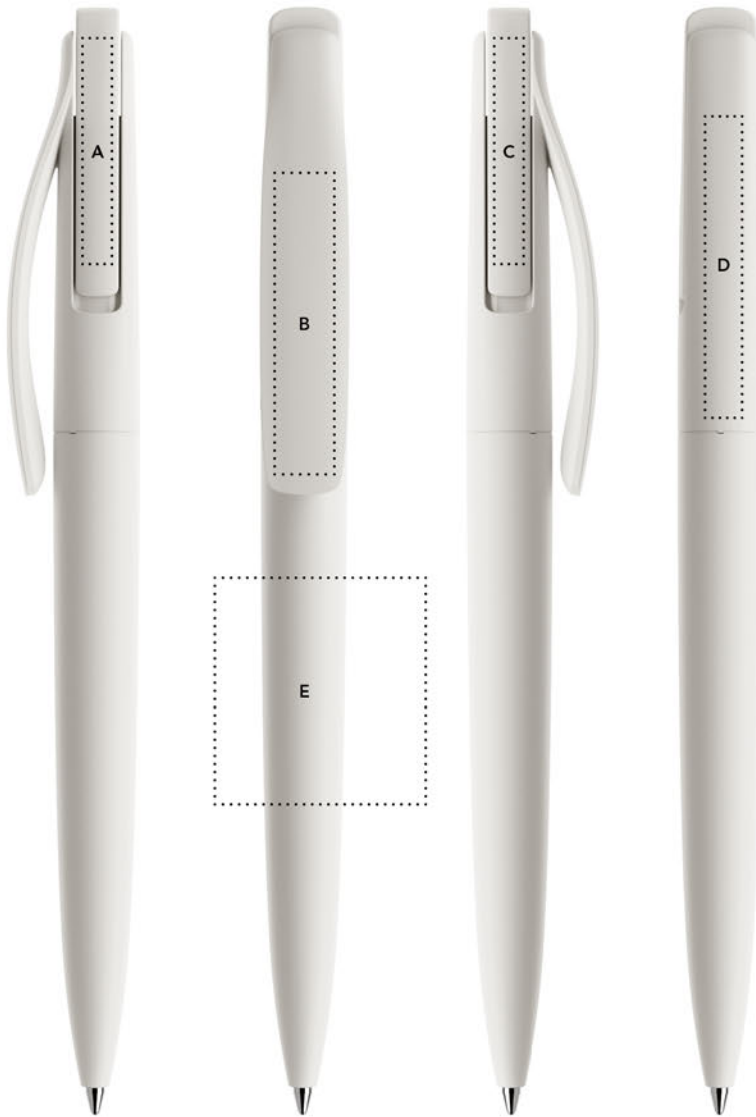

Print areas

		mm	Inch	Print	Notes
A	Button (right)	30 × 4	1,18 × 0,16	1 colour	-
B	Clip	40 × 8	1,57 × 0,31	6 colours	-
C	Button (left)	30 × 4	1,18 × 0,16	1 colour	-
D	Back cap	40 × 5	1,57 × 0,20	1 colour	-
E	Body	30 × 28	1,18 × 1,10	4 colours	-



Frosted

DS2 PFF-F

Cap	F10
Barrel	F10
Button	F10

Frosted

DS2 PFF-T

Cap	F55
Barrel	F55
Button	T55

Transparent

DS2 PTC-T

Cap	T50
Body	T50
Nose cone	C70
Button	T50

DS2

DS3

DS3.1

DS4

DS5

DS7

DS8

DS9

DNA

Cases



Transparent

DS2 PTT-T

Cap	T76
Barrel	T76
Button	T76

Matt

DS2 PMM-T

Cap	M02
Barrel	M02
Button	T20

Matt

DS2 PMS-M

Cap	M49
Body	M49
Nose cone	S70
Button	M49

New!



35

36

Matt

DS2 PMM- M

Cap	M61
Barrel	M61
Button	M61

Polished

DS2 PPP-T

Cap	P20
Barrel	P20
Button	T20

Polished

DS2 PPP-P

Cap	P75
Barrel	P75
Button	P02

New!

DS2

DS3

DS3.1

DS4

DS5

DS7

DS8

DS9

DNA

Cases

DS3

It catches the eye because it's good, not because it's loud. The icon amongst promotional writing instruments. The original: timeless and unmistakable.

[deu] Er fällt auf, weil er gut ist, nicht weil er laut ist. Die Ikone unter den Schreibgeräten für die Promotion. Das Original, zeitlos und unverwechselbar.

[fra] Il se distingue par sa qualité, pas par le bruit fait autour de lui. C'est l'icône des instruments d'écriture promotionnels. L'original, intemporel et unique.

[esp] Llama la atención porque es bueno, y no por hacer ruido. El icono de los instrumentos de escritura para fines promocionales. El original, atemporal e inconfundible.

[ita] Si distingue perché vale, non perché fa rumore. È l'icona degli strumenti di scrittura promozionali. L'originale, inconfondibile e senza tempo.

[rus] Она притягивает к себе взгляд лаконичным дизайном, а не кричащими формами. Икона среди рекламных пишущих инструментов. Оригинальная: вне времени и пространства.



DS3

DS3.1

DS4

DS5

DS7

DS8

DS9

DNA

Cases

Product code

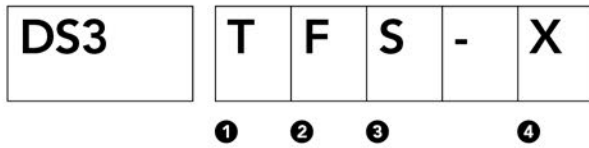

Fastlane

5.000 pens in 5 days.
Find out more on page 181.

① Writing system

- T Twist ball pen
- M Mechanical pencil



② Cap and body

- F Frosted
- T Transparent
- M Matt
- P Polished
- V Varnished matt
- A Varnished polished
- R Soft touch
- B Biotic
- N Regenerated



③ Nose cone

- F Frosted
- T Transparent
- M Matt
- P Polished
- V Varnished matt
- A Varnished polished
- R Soft touch
- B Biotic
- N Regenerated
- S Satin finish metal
- C Chrome finish metal



④ Ring

- X Polished



Refills

Standard Floating Ball® lead free 1.0 mm
All Prodir pens are refillable. Discover other options on page 168.

Ring option (Not available for Soft touch, biotic and regenerated surfaces)



Cap, body and nose cone (* Also for mechanical pencil)

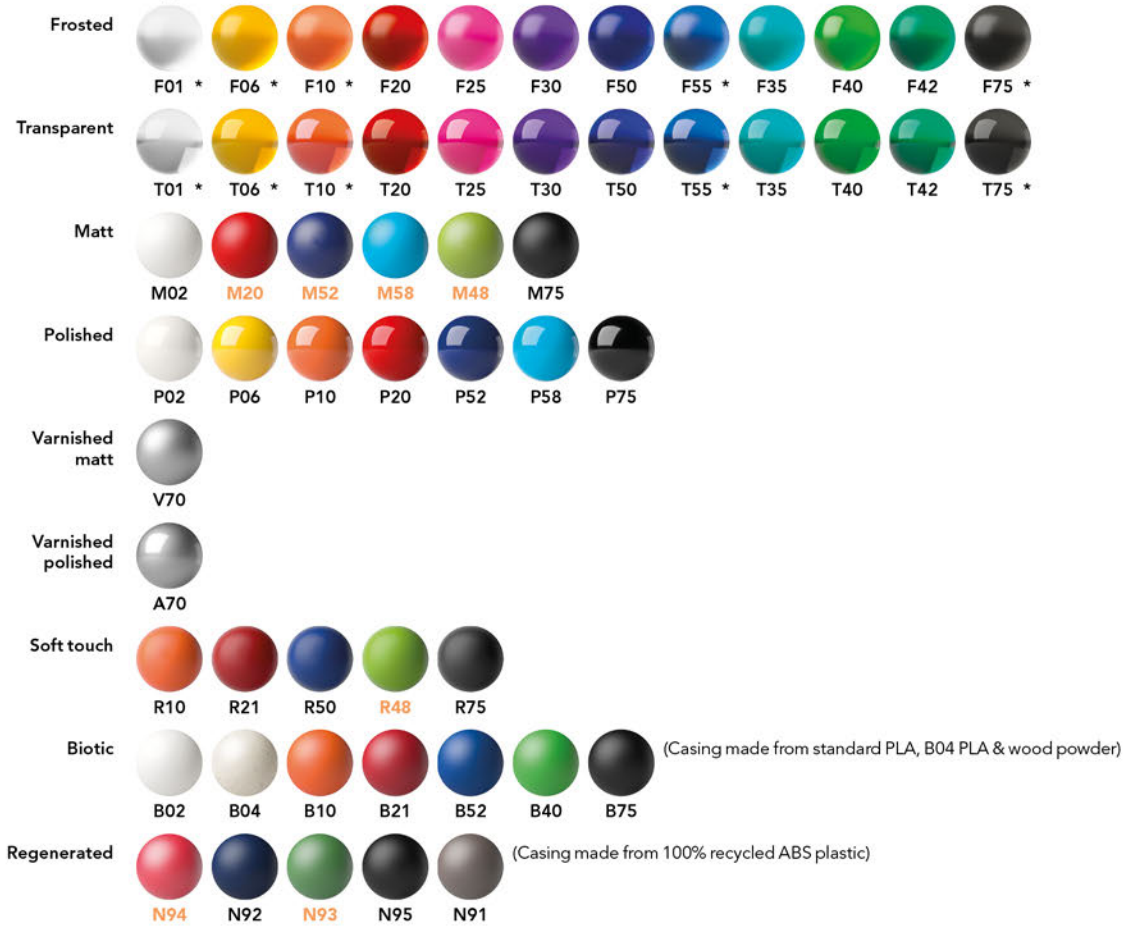

Metal nose cone (Not available for Soft touch, biotic and regenerated surfaces)



Designer's choice (Starting from 5.000 pieces)

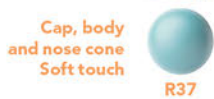

New surface and colours!

DS3

DS3.1

DS4

DS5

DS7

DS8

DS9

DNA

Cases

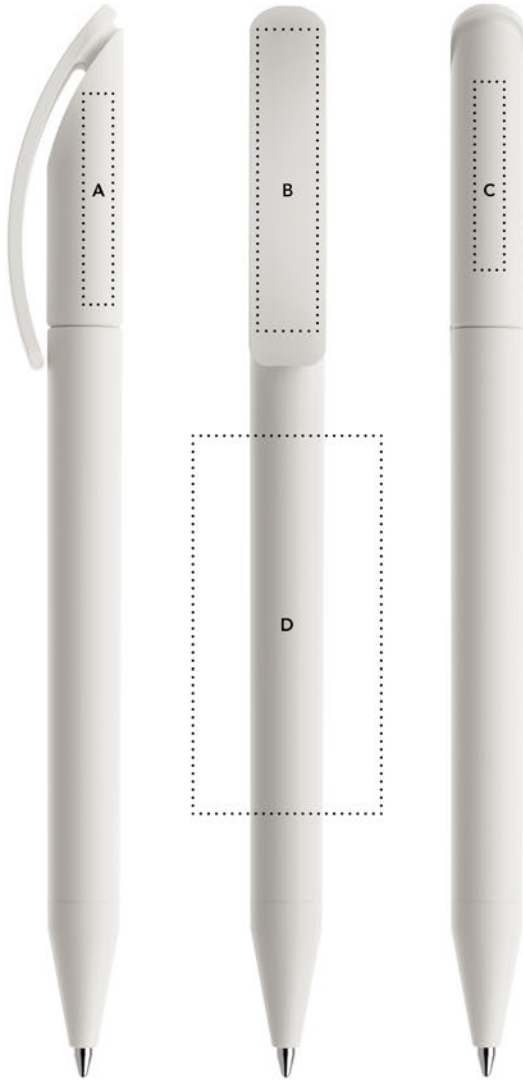

Print areas

		mm	Inch	Print	Notes
A	Side cap	28 x 4	1,10 x 0,16	1 colour	Not available for Biotic surface
B	Clip	40 x 8	1,57 x 0,31	6 colours	Soft touch version 2 colours
C	Back cap	25 x 4	0,98 x 0,16	1 colour	Not available for Soft touch and regenerated surfaces
D	Body	50 x 25	1,97 x 0,98	4 colours	Not available for Soft touch surface



Frosted

DS3 MFF

Cap F10
 Body F10
 Nose cone F10

Transparent

DS3 TTC-X

Cap T01
 Body T01
 Nose cone C70
 Ring X20

Matt

DS3 TMM

Cap M58
 Body M58
 Nose cone M58

New!

DS3

DS3.1

DS4

DS5

DS7

DS8

DS9

DNA

Cases



Polished

DS3 TPP

Cap	P20
Body	P20
Nose cone	P20

Varnished polished

DS3 TAA

Cap	A70
Body	A70
Nose cone	A70

Soft touch

DS3 TRR

Cap	R75
Body	R75
Nose cone	R75



Soft touch

DS3 TRR

Cap R37
 Body R37
 Nose cone R37

Biotic

DS3 TBB

Cap B40
 Body B40
 Nose cone B40

Regenerated

DS3 TNN

Cap N92
 Body N92
 Nose cone N92

Designer's choice

New!

DS3

DS3.1

DS4

DS5

DS7

DS8

DS9

DNA

Cases

DS3.1

The icon, slightly redesigned, with a larger clip and an even more flexible twist mechanism. The evolution of the classic pen.

[deu] Die Ikone, leicht überarbeitet, mit einem grösseren Clip und einem noch geschmeidigeren Drehmechanismus. Die Evolution des Klassikers.

[fra] Le modèle icône, légèrement modifié, avec une agrafe plus large et un mécanisme pivotant encore plus souple. L'évolution d'un classique.

[esp] El icono, ligeramente rediseñado, con un clip más grande y un mecanismo de giro aún más suave. La evolución del clásico.

[ita] La nostra icona ristilizzata con una clip più ampia ed un meccanismo a rotazione ancora più morbido. L'evoluzione della classica penna.

[deu] Икона стиля: с незначительными усовершенствованиями, увеличенным размером клипа и более изящным механизмом вращения. Эволюция классики.



DS3.1

DS4

DS5

DS7

DS8

DS9

DNA

Cases

Product code

DS3.1	T	P	P
-------	---	---	---

① ② ③

① Writing system

T Twist ball pen
with extra smooth mechanism



② Cap and body

F Frosted
T Transparent
P Polished



③ Nose cone

F Frosted
T Transparent
P Polished
S Satin finish metal
C Chrome finish metal



Refills

Standard Floating Ball® lead free 1.0 mm
All Prodir pens are refillable. Discover other options on page 168.

Cap, body and nose cone

Frosted



F01 F26 F59 F75

Transparent



T01 T10 T26 T25 T30 T59 T55 T53 T36 T48 T75

Polished



P02 P07 P20 P31 P77 P75

Metal nose cone

Satin
finish metal



S70

Chrome
finish metal



C70

Designer's choice (Starting from 5.000 pieces)

Cap, body
and nose cone
Polished



P37

New surface and colours!

DS3.1

DS4

DS5

DS7

DS8

DS9

DNA

Cases

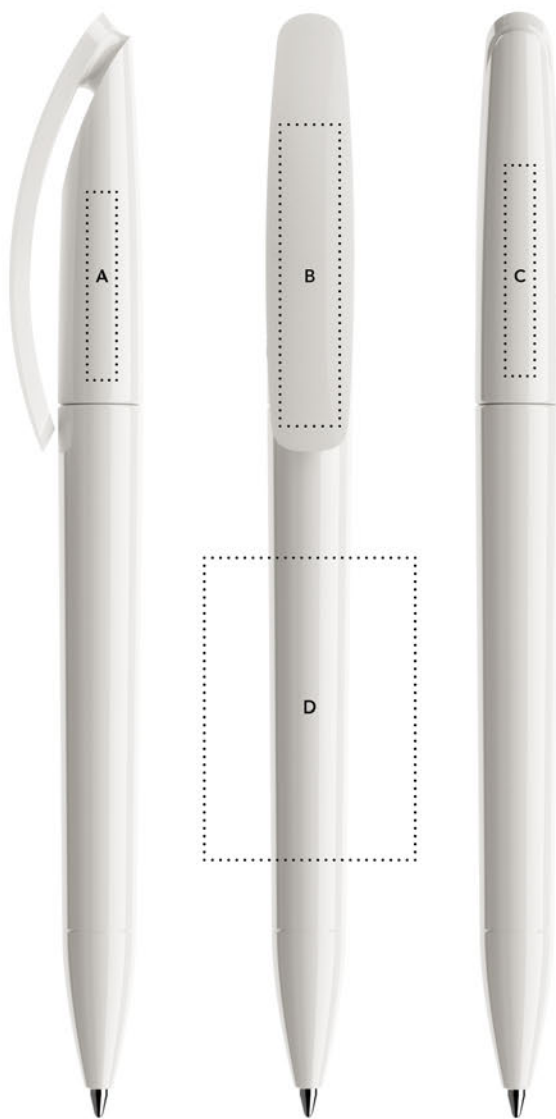

Print areas

		mm	Inch	Print	Notes
A	Side cap	25 x 4	0,98 x 0,16	1 colour	-
B	Clip	40 x 8	1,57 x 0,31	6 colours	-
C	Back cap	28 x 4	1,10 x 0,16	1 colour	-
D	Body	40 x 28	1,57 x 1,10	4 colours	-



Frosted

DS3.1 TFS

Cap F01
 Body F01
 Nose cone S70

Frosted

DS3.1 TFS

Cap F75
 Body F75
 Nose cone S70

Transparent

DS3.1 TTT

Cap T36
 Body T36
 Nose cone T36

DS3.1

DS4

DS5

DS7

DS8

DS9

DNA

Cases



Transparent

DS3.1 TTT

Cap T30
Body T30
Nose cone T30

Transparent

DS3.1 TTT

Cap T26
Body T26
Nose cone T26

Transparent

DS3.1 TTC

Cap T10
Body T10
Nose cone C70



DS3.1

DS4

DS5

DS7

DS8

DS9

DNA

Cases

Polished

DS3.1 TPP

Cap P07
Body P07
Nose cone P07

Polished

DS3.1 TPP

Cap P02
Body P02
Nose cone P02

Polished

DS3.1 TPC

Cap P75
Body P75
Nose cone C70

DS4

Until now, our writing instruments were always round or triangular. Now, the DS4 brings the square into play. It makes a surprising impact through well-conceived details such as an elegant surface mix, a 45° slightly rotated clip, and a vivid, very contemporary colour range in matt and Soft touch.

[deu] Bisher waren unsere Schreibgeräte immer rund oder dreieckig. Jetzt bringt der DS4 das Quadrat ins Spiel. Er überrascht mit durchdachten Details wie edlem Oberflächenmix, einem leicht um 45° gedrehten Clip und einer starken, sehr aktuellen Farbpalette in Matt und Soft touch.

[fra] Jusqu'à présent, nos instruments d'écriture étaient toujours ronds ou triangulaires. Maintenant, le DS4 fait entrer le carré dans le jeu. Il surprend par des détails bien pensés tels qu'un mélange noble de surfaces, un clip légèrement pivoté de 45° et une palette de couleurs vives, très actuelles, en mat et Soft touch.

[esp] Hasta ahora nuestros instrumentos de escritura siempre eran redondos o triangulares, pero el DS4 recurre por primera vez al cuadrado. Sorprende con detalles sofisticados como un mix noble de superficies, un clip girado ligeramente en 45° y una paleta de colores viva y muy actual en mate y Soft touch.

[ita] I nostri strumenti di scrittura sono sempre stati rotondi o triangolari. Oggi, con la DS4, entra in gioco il quadrato. Una penna che sorprende per i dettagli studiati come l'elegante mix di superfici, la leggera rotazione di 45° della clip e una gamma di colori decisi e attuali in versione opaca e Soft touch.

[rus] До сих пор наши письменные приборы всегда были круглыми или треугольными. Теперь новая ручка DS4 вводит в игру квадрат. Она впечатляет такими продуманными деталями, как благородный микс поверхностей, слегка повернутый на 45° клип и насыщенная, очень актуальная цветовая палитра в матовом исполнении и в варианте Soft touch.



DS4

DS5

DS7

DS8

DS9

DNA

Cases

Product code

DS4	P	M	M	-	P
	①	②	③		④

① Writing system

P Push ball pen



② Body

M Matt
R Soft touch



③ Nose cone

M Matt
R Soft touch



④ Button

P Polished
Y Galvanized satin
Z Galvanized chrome



Refills

Standard Floating Ball® lead free 1.0 mm
All Prodir pens are refillable. Discover other options on page 168.

Button

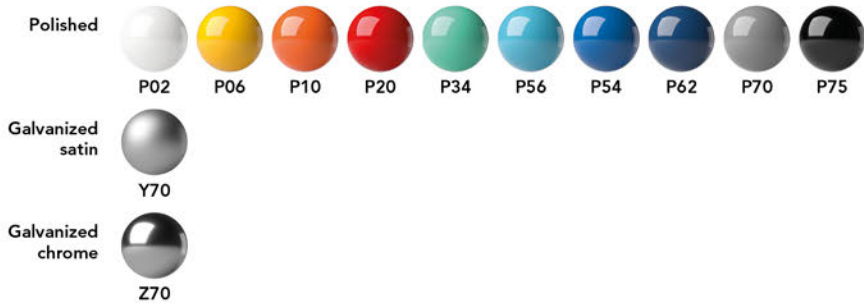

Clip



Body and nose cone

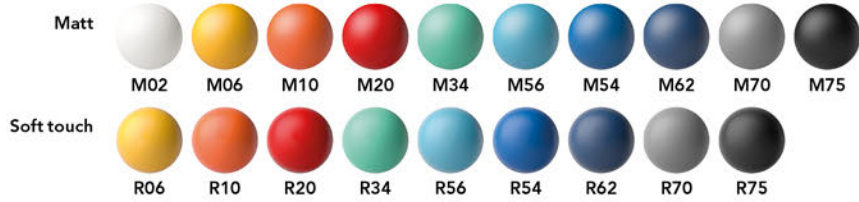

Designer's choice (Starting from 5.000 pieces)



New surface and colours!

DS4

DS5

DS7

DS8

DS9

DNA

Cases

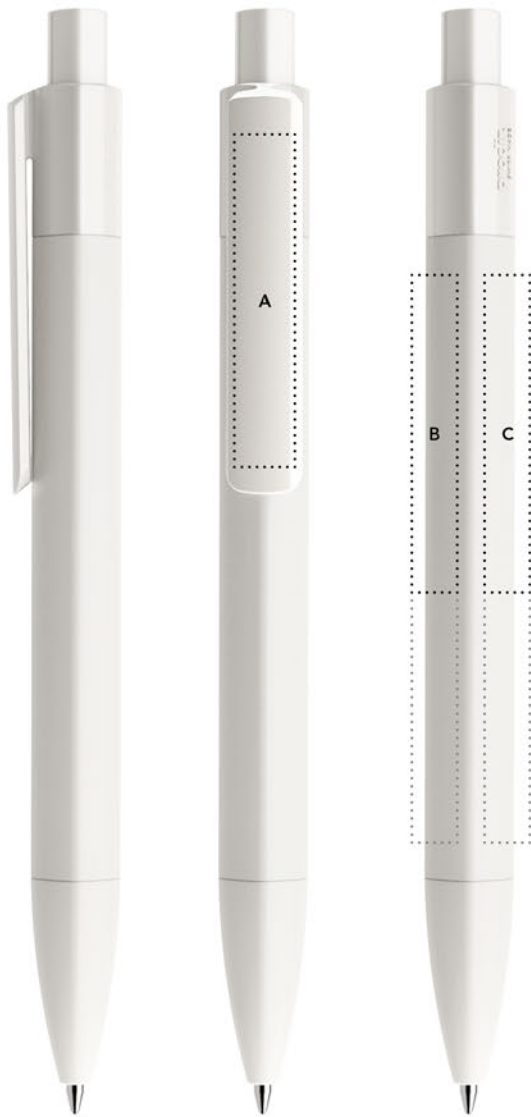

Print areas

		mm	Inch	Print	Notes
A	Clip	44 x 8	1,73 x 0,31	6 colours	-
B	Back side (right)	42 x 6	1,65 x 0,24	2 colours	-
C	Back side (left)	42 x 6	1,65 x 0,24	2 colours	-



Matt

DS4 PMM-P

Body	M02
Clip	P02
Nose cone	M02
Button	P02

Matt

DS4 PMM-P

Body	M70
Clip	P70
Nose cone	M70
Button	S70

Matt

DS4 PMM-P

Body	M34
Clip	P06
Nose cone	M20
Button	P56

DS4

DS5

DS7

DS8

DS9

DNA

Cases



Matt

DS4 PMM-P

Body	M10
Clip	P10
Nose cone	M10
Button	P10

Soft touch

DS4 PRR-P

Body	R56
Clip	P56
Nose cone	R56
Button	P56

Soft touch

DS4 PRR-P

Body	R34
Clip	P34
Nose cone	R34
Button	P34



Soft touch

DS4 PRR-P

Body	R70
Clip	P70
Nose cone	R70
Button	P70

Soft touch

DS4 PRR-P

Body	R75
Clip	P75
Nose cone	R75
Button	P75

Soft touch

DS4 PRR-P

Body	R54
Clip	P02
Nose cone	R54
Button	P10

DS4

DS5

DS7

DS8

DS9

DNA

Cases

DS5

When it's about having that little extra something, then this is the right one: more colours, more surfaces, more personalization, more printing surfaces. All that, plus a design honoured with prestigious awards.

[deu] Wenn es ein bisschen mehr darf soll, dann ist er der Richtige: mehr Farben, mehr Oberflächen, mehr Personalisierung, mehr Druckflächen. Und das in einem mit renommierten Preisen ausgezeichneten Design.

[fra] Si c'est une petite note spéciale que vous recherchez, vous avez ce qu'il vous faut : plus de couleurs, plus de surfaces, plus de personnalisation, plus de zones d'impression. Et pour couronner le tout, un design récompensé par de prestigieux awards.

[esp] Si lo que se quiere es un poco más, este es el adecuado: más colores, más superficies, más personalización, más superficies de impresión. Y todo ello con un diseño que viene reconocido por prestigiosos premios.

[ita] Se desideri quel tocco in più, questa sarà la scelta giusta: più colori, più superfici, più personalizzazioni, più aree di stampa. Il tutto con un design coronato da prestigiosi premi.

[rus] Если размер должен быть немного больше, она - то, что надо: больше цветов, больше поверхностей, больше персонализации, больше поверхности для нанесения печати. И все это - грани дизайна, удостоившегося самых престижных премий.



Good Design
Award



DS5

DS7

DS8

DS9

DNA

Cases

Product code

DS5	T	F	S	-	P
	①	②	③		④

Fastlane

5.000 pens in 5 days.
Find out more on page 181.

① Writing system

T Twist ball pen



② Cap and body

F Frosted
T Transparent
M Matt
P Polished
V Varnished matt
R Soft touch
N Regenerated



③ Nose cone

F Frosted
T Transparent
M Matt
P Polished
V Varnished matt
R Soft touch
N Regenerated
S Satin finish metal
C Chrome finish metal



④ Clip cover

M Matt
P Polished



Refills

Standard Floating Ball® lead free 1.0 mm
All Prodir pens are refillable. Discover other options on page 168.

Clip cover option (Available only for Soft touch surfaces)



Cap, body and nose cone

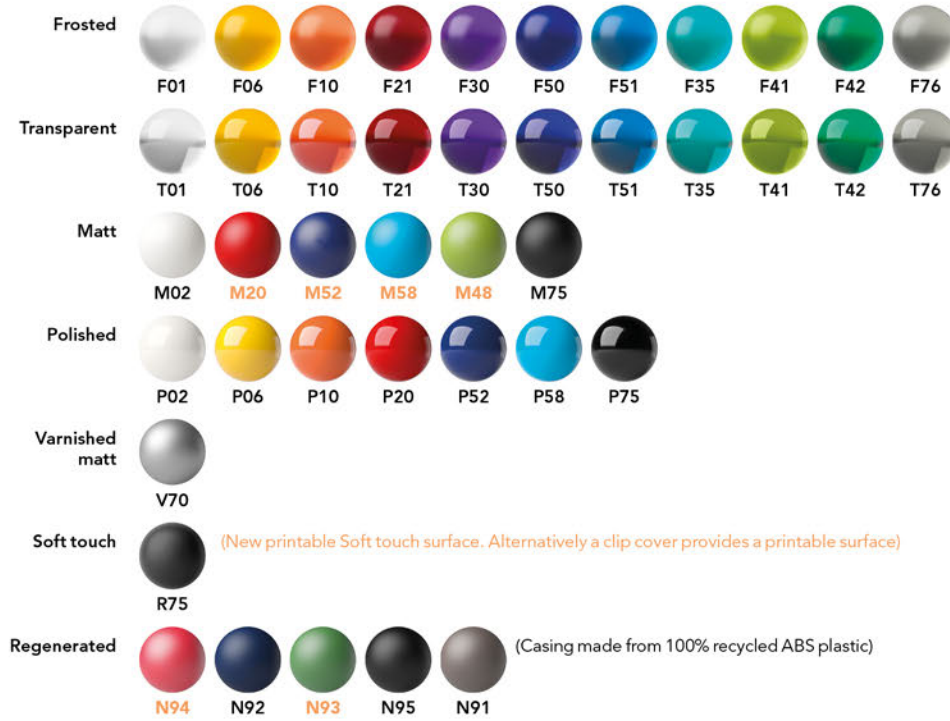

Metal nose cone (Not available for Soft touch and regenerated surfaces)



Designer's choice (Starting from 5.000 pieces)



New surface and colours!

DS5

DS7

DS8

DS9

DNA

Cases

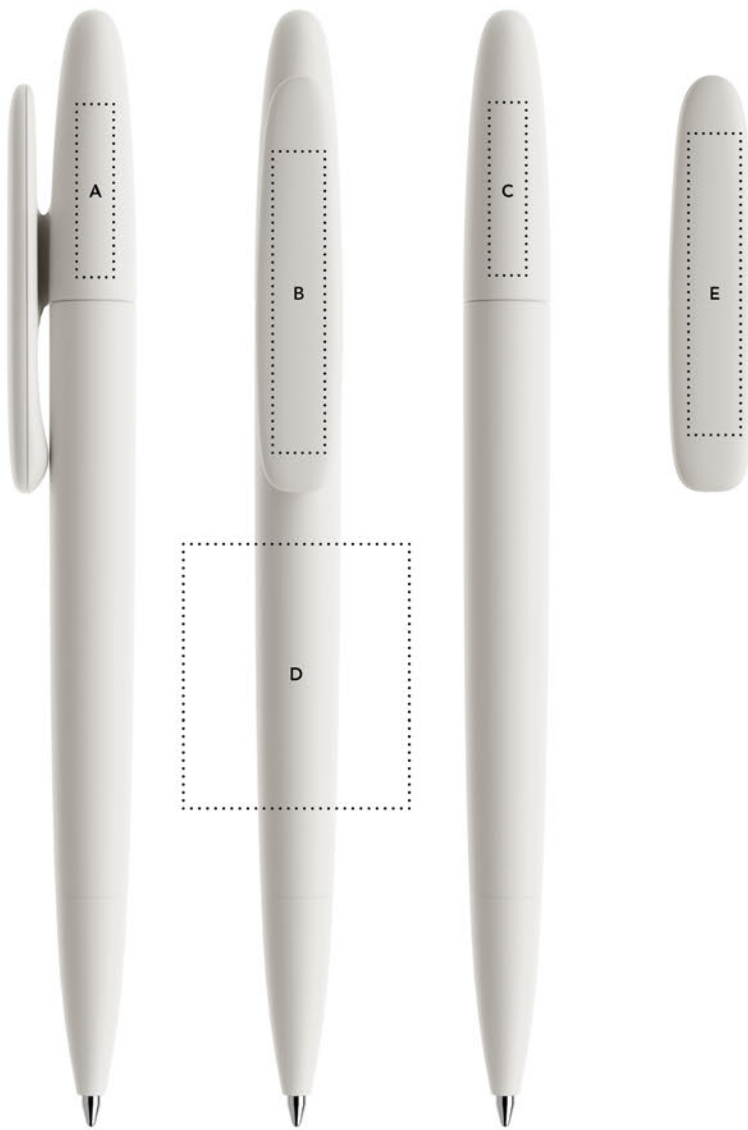

Print areas

		mm	Inch	Print	Notes
A	Side cap	23 x 5	0,90 x 0,20	1 colour	-
B	Clip	40 x 7	1,57 x 0,28	6 colours	Soft touch version 2 colours
C	Back cap	23 x 5	0,90 x 0,20	1 colour	Not available for regenerated surfaces
D	Body	35 x 30	1,38 x 1,18	4 colours	Not available for Soft touch surface
E	Clip cover	40 x 7	1,57 x 0,28	2 colours	-



Frosted

DS5 TFF

Cap F76
Body F76
Nose cone F76

Transparent

DS5 TTC

Cap T35
Body T35
Nose cone C70

Transparent

DS5 TTT

Cap T06
Body T06
Nose cone T06

DS5

DS7

DS8

DS9

DNA

Cases



Matt

DS5 TMM

Cap	M37
Body	M37
Nose cone	M37

Designer's choice

Matt

DS5 TMM

Cap	M58
Body	M58
Nose cone	M58

New!

Polished

DS5 TPP

Cap	P20
Body	P20
Nose cone	P20



Varnished matt

DS5 TVS

Cap	V70
Body	V70
Nose cone	S70

Soft touch

DS5 TRR-P

Cap	R75
Body	R75
Nose cone	R75
Clip cover	P75

Regenerated

DS5 TNN

Cap	N93
Body	N93
Nose cone	N93

New!

DS5

DS7

DS8

DS9

DNA

Cases

DS7

When it comes to easy elegance, nothing can match it. Value enhancing and well balanced, the push button in the middle provides a subtle colour accent.

[deu] Wenn es um lässige Eleganz geht, reicht ihm keiner das Wasser. Wertig und harmonisch, setzt der Druckknopf in der Mitte einen dezenten Farbakzent.

[fra] En matière d'élégance légère, il est incomparable. Qualité et harmonie, le bouton-poussoir au milieu du corps place un accent coloré mais discret.

[esp] Cuando de lo que se trata es de la ligera elegancia, nadie le llega a la suela del zapato. El botón de presión del centro, armónico y de alta calidad, aporta un discreto toque de color.

[ita] Quando si tratta di eleganza leggera, non è seconda a nessuna. Elemento di preziosa armonia, il pulsante al centro è un delicato tocco di colore.

[rus] Когда речь идёт о лёгкой эlegantности, она не имеет себе равных. Нажимная кнопка в середине ставит сдержанный цветовой акцент, достойно и гармонично.



The Promotional Gift
Award Winner



DS7

DS8

DS9

DNA

Cases

Product code

DS7	P	F	S	-	F
-----	---	---	---	---	---

① ② ③ ④

① Writing system

P Push ball pen



② Cap and body

F Frosted
T Transparent
M Matt
P Polished



③ Nose cone

F Frosted
T Transparent
M Matt
P Polished
S Satin finish metal
C Chrome finish metal



④ Button

F Frosted
M Matt



Refills

Standard Floating Ball® lead free 1.0 mm
All Prodir pens are refillable. Discover other options on page 168.

Cap, body and nose cone



Button



Metal nose cone



Designer's choice (Starting from 5.000 pieces)



New surface and colours!

DS7

DS8

DS9

DNA

Cases

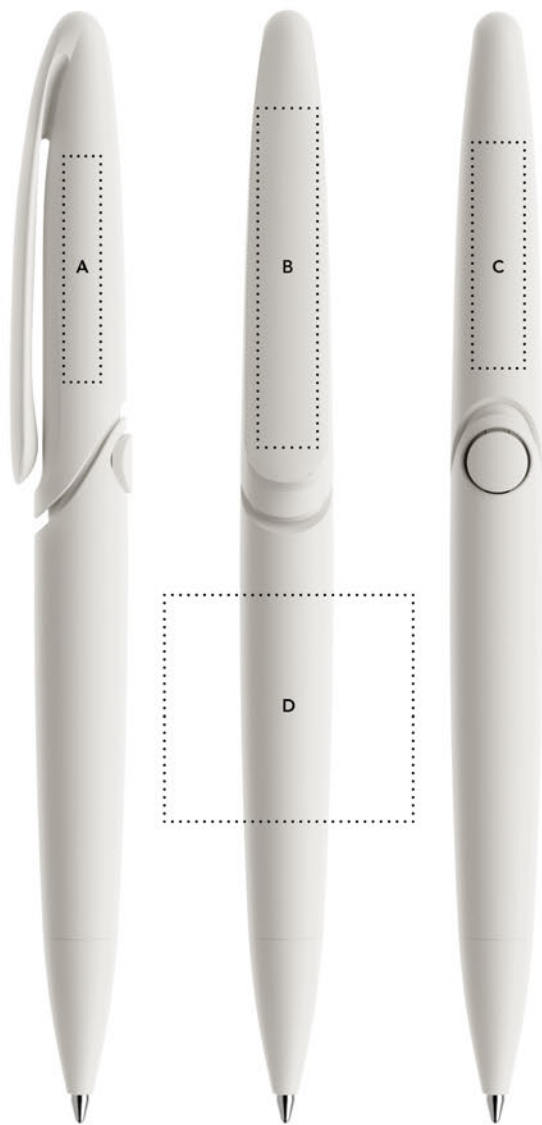

Print areas

		mm	Inch	Print	Notes
A	Side cap	30 x 5	1,18 x 0,20	1 colour	-
B	Clip	45 x 8	1,77 x 0,31	6 colours	-
C	Back cap	30 x 7	1,18 x 0,28	1 colour	-
D	Body	30 x 33	1,18 x 1,30	4 colours	-



Frosted

DS7 PFS-F

Cap	F01
Body	F01
Nose cone	S70
Button	F76

Frosted

DS7 PFS-F

Cap	F76
Body	F76
Nose cone	S70
Button	F21

Transparent

DS7 PTC-F

Cap	T21
Body	T21
Nose cone	C70
Button	F21

DS7

DS8

DS9

DNA

Cases



Transparent

DS7 PTT-F

Cap	T10
Body	T10
Nose cone	T10
Button	F50

Transparent

DS7 PTT-F

Cap	T50
Body	T50
Nose cone	T50
Button	F06

Matt

DS7 PMS-M

Cap	M75
Body	M75
Nose cone	S70
Button	M75



Polished

DS7 PPC-M

Cap	P02
Body	P02
Nose cone	C70
Button	M75

Polished

DS7 PPP-F

Cap	P74
Body	P74
Nose cone	P74
Button	M41

Polished

DS7 PPP-M

Cap	P41
Body	P41
Nose cone	P41
Button	M41

DS7

DS8

DS9

DNA

Cases

DS8

The icon of a classic writing instrument. A timeless interpretation of the triangular form in an ergonomically optimized design. Functional right down to the last detail. Relaxed writing with a self-confident, high-quality ballpoint pen. Also available as a mechanical pencil.

[deu] Die Ikone eines klassischen Schreibgeräts. Eine zeitlose Interpretation der Dreiecksform in einem ergonomisch optimierten Design. Funktional bis ins Detail. Entspanntes Schreiben mit einem selbstbewusst wertigen Kugelschreiber. Auch als Druckbleistift.

[fra] L'icône du classicisme en instrument d'écriture. Une interprétation intemporelle de la forme triangulaire, dans un design à l'ergonomie optimisée. Fonctionnel jusque dans les moindres détails. Une écriture toute en souplesse avec un stylo à bille qui exprime clairement la valeur. Existe aussi en porte-mine.

[esp] El icono de un bolígrafo clásico. Una interpretación atemporal de la forma triangular en un diseño optimizado ergonómicamente. Funcional hasta en los detalles. Escritura relajada con un bolígrafo elegante y seguro de sí mismo. También disponible como portaminas.

[ita] L'icona di un classico strumento di scrittura. Un'interpretazione intramontabile della forma triangolare in un nuovo design più ergonomico. Funzionale in ogni dettaglio. Per una scrittura morbida e piacevole, con una penna che sa di valere. Disponibile anche come portamine.

[rus] Икона среди классических ручек. Неподвластная времени интерпретация треугольной формы, воплощённая в дизайнерском решении, улучшенном с точки зрения эргономичности. Функциональна до мелочей. Мягкое письмо добротной шариковой ручки с твердым характером. Теперь и в виде механического карандаша.



DS8

DS9

DNA

Cases

Product code

DS8	P	M	M	-	S
-----	---	---	---	---	---

①

②

③

④

Fastlane

5.000 pens in 5 days.
Find out more on page 181.

① Writing system

- P Push ball pen
- M Mechanical pencil



② Cap

- M Matt
- P Polished
- R Soft touch
- N Regenerated



③ Barrel

- M Matt
- P Polished
- R Soft touch
- N Regenerated



④ Button

- T Transparent
- P Polished
- J Regenerated
- S Satin finish metal
- C Chrome finish metal



Refills

Standard Floating Ball® lead free 1.0 mm
All Prodir pens are refillable. Discover other options on page 168.

Button

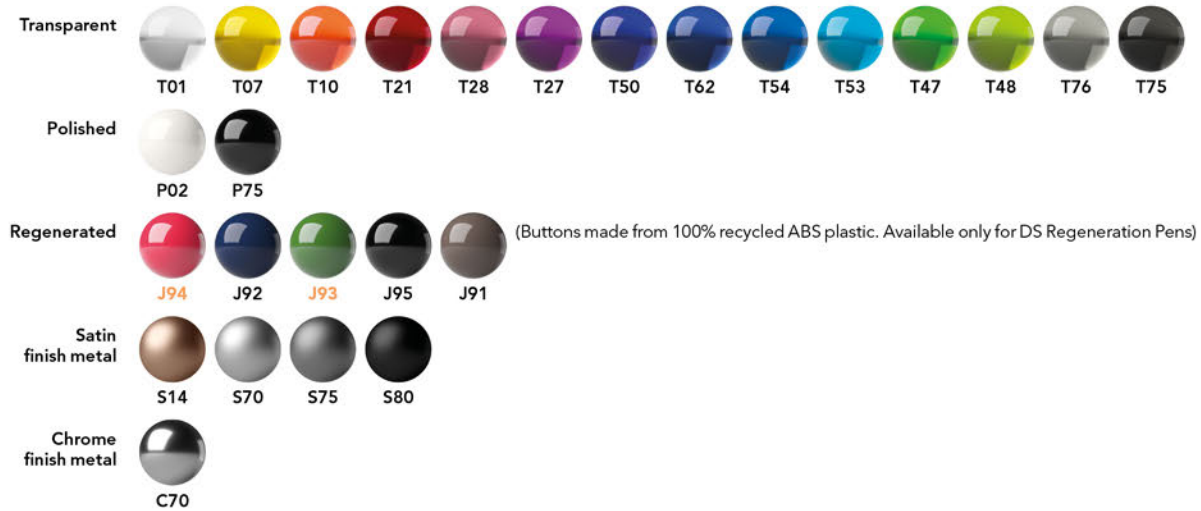

Clip

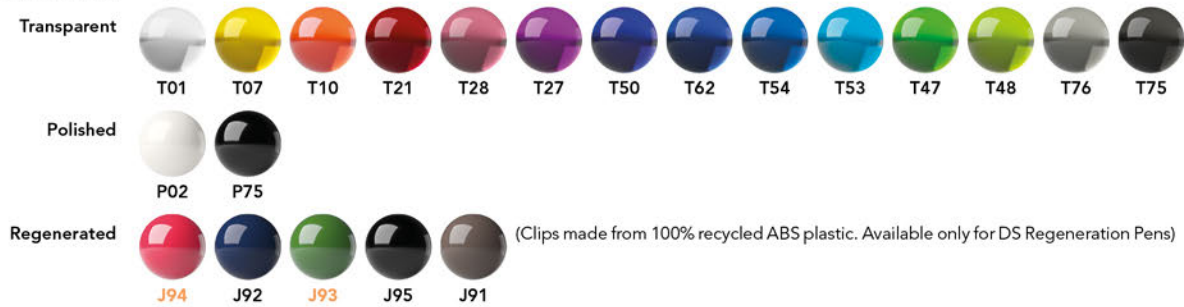

Cap and barrel (* Also for mechanical pencil delivered exclusively with satin or chrome finish metal button)



Designer's choice (Starting from 5.000 pieces. Not available for mechanical pencil)



New surface and colours!

DS8

DS9

DNA

Cases



DS8

Print areas

		mm	Inch	Print	Notes
A	Side cap	38 x 5	1,50 x 0,20	2 colours	Not available for regenerated surface
B	Clip	36 x 7	1,41 x 0,28	6 colours	-
C	Body	36 x 5	1,41 x 0,20	2 colours	-
C1	Side body	36 x 5	1,41 x 0,20	2 colours	-
C2	Side body	36 x 5	1,41 x 0,20	2 colours	-



Matt

DS8 PMM-T

Cap	M70
Barrel	M70
Clip	T76
Button	T76

Matt

DS8 PMM-T

Cap	M07
Barrel	M07
Clip	T07
Button	T07

Polished

DS8 PPP-P

Cap	P02
Barrel	P02
Clip	P02
Button	P02

DS8

DS9

DNA

Cases



Polished

DS8 PPP-P

Cap	P20
Barrel	P20
Clip	P02
Button	P02

Soft touch

DS8 PRR-S

Cap	R10
Barrel	R10
Clip	P75
Button	S70

Soft touch

DS8 MRR-C

Cap	R50
Barrel	R50
Clip	T50
Button	C70



Soft touch

DS8 PRR-P

Cap	R75
Barrel	R75
Clip	P75
Button	P75

Regenerated

DS8 PNN-J

Cap	N91
Barrel	N91
Clip	J91
Button	J91

Regenerated

DS8 PNN-J

Cap	N93
Barrel	N93
Clip	J93
Button	J93

New!

DS8

DS9

DNA

Cases

DS8

Metal clip

Attractive clip/push button combinations in metal make the DS8 even more versatile. The standard design has a silver satin finish metal clip and a satin or chrome finish metal push button. There is also a choice of options in galvanized Copper, Black, Grey and varnished White: the metal clip always comes in a matt finish and the push button can be either matt or polished. A balanced mix of metal and plastic for clever logo display.

[deu] Wertige Clip-Druckknopf-Kombinationen aus Metall machen den DS8 noch vielseitiger. Die Standardausführung ist mit silberfarbenem Clip / Druckknopf ausgestattet. Als Option stehen Kombinationen in galvanisiertem Kupfer, Schwarz oder Grau sowie weiss lackiert zur Auswahl: Die Metallclips sind dabei immer satiniert, der Druckknopf entweder satiniert oder glänzend. Ein ausgewogener Material-Mix aus Metall und Kunststoff, der Marken gekonnt in Szene setzt.

[fra] Différentes combinaisons agrafe bouton-poussoir en métal ajoutent encore de la diversité au DS8. La version standard est équipée d'une agrafe et d'un bouton-poussoir couleur argent. En option, il est proposé des combinaisons en cuivre galvanisé, en noir ou gris ainsi qu'en blanc laqué : dans ce cas, l'agrafe métal est toujours satinée, le bouton-poussoir soit satiné, soit chromé. Un mélange équilibré entre le métal et la matière plastique qui met en scène les marques de manière savante.

[esp] Unas elegantes combinaciones de clip y botón de presión de metal hacen aún más versátil al DS8. El modelo estándar está equipado con clip/botón de presión de color plata. Opcionalmente, es posible elegir entre combinaciones en cobre galvanizado, negro o gris, así como blanco lacado: Los clips metálicos son siempre satinados, el botón de presión puede ser satinado o cromado. Una mezcla equilibrada de materiales, con metal y plástico, que pone marcas en escena con maestría.

[ita] Raffinate combinazioni di clip e pulsante in metallo rendono la DS8 ancora più versatile: la versione standard è dotata di clip / pulsante di colore argento. Su richiesta sono disponibili combinazioni in rame galvanizzato, nero o grigio, nonché laccato bianco: in queste versioni, le clip sono sempre in metallo satinato, mentre il pulsante può essere satinato o lucido. Un armonioso mix di metallo e plastica che mette in scena con maestria il tuo marchio.

[rus] Сочетание клипа и нажимной кнопки из металла делают ручку DS8 еще разностороннее. В стандартном исполнении ручка оснащена клипом/нажимной кнопкой серебристого цвета. В качестве опции доступно сочетание гальванического медного, черного или серого цвета, а также белого лака: металлический клип при этом всегда остается матовым, нажимная кнопка может быть либо матовой, либо блестящей. Сбалансированное сочетание металла и пластмассы для профессионального продвижения бренда.



DS8
Metal
clip

DS9

DNA

Cases

Product code

DS8	P	S	M	-	S
-----	---	---	---	---	---

① ② ③ ④

① Writing system

- P Push ball pen
- M Mechanical pencil



② Metal clip

- S Satin finish metal



③ Cap and barrel

- M Matt
- P Polished
- R Soft touch



④ Button

- T Transparent
- P Polished
- S Satin finish metal
- C Chrome finish metal

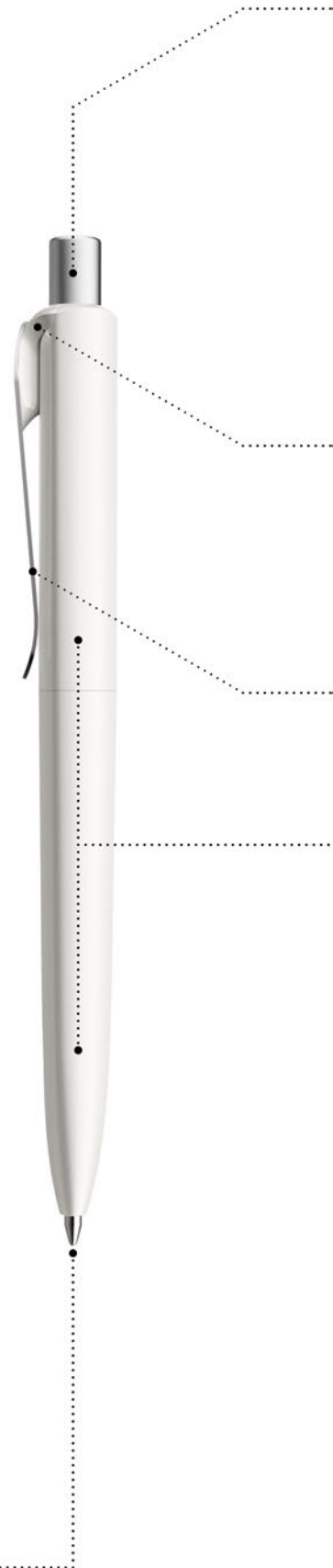

Refills

Standard Floating Ball® lead free 1.0 mm
All Prodir pens are refillable. Discover other options on page 168.

Button

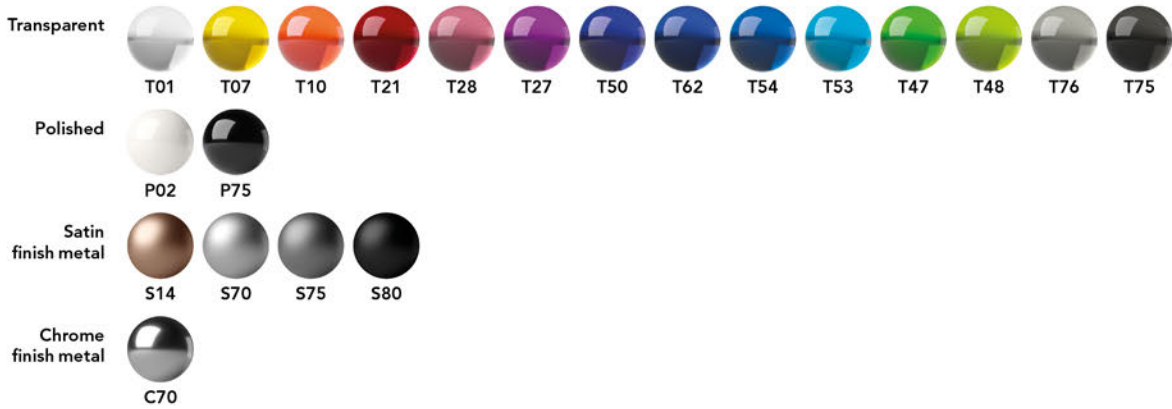

Clip holder



Metal clip

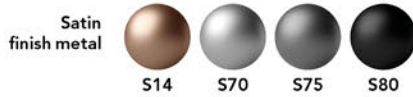

Body (* Also for mechanical pencil delivered exclusively with satin or chrome finish metal button)



Designer's choice (Starting from 5.000 pieces. Not available for mechanical pencil)



New surface and colours!

DS8
Metal clip

DS9

DNA

Cases

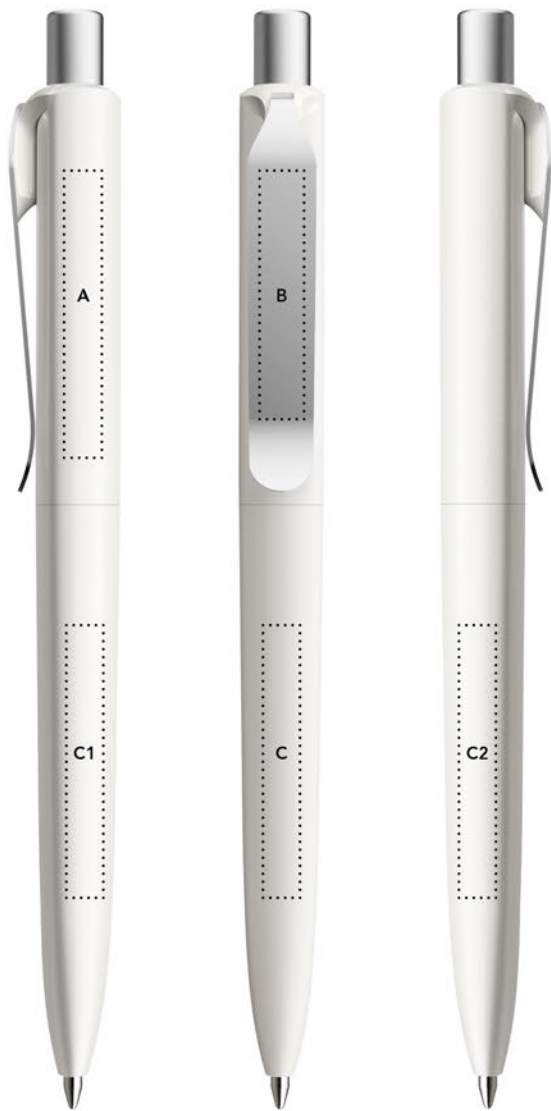

Print areas

		mm	Inch	Print	Notes
A	Side cap	38 x 5	1,50 x 0,20	2 colours	-
B	Metal clip	33 x 6	1,29 x 0,23	4 colours	Pad printing or laser engraving
C	Body	36 x 5	1,41 x 0,20	2 colours	-
C1	Side body	36 x 5	1,41 x 0,20	2 colours	-
C2	Side body	36 x 5	1,41 x 0,20	2 colours	-



Matt

DS8 PSM-S

Cap	M02
Barrel	M02
Clip	S70
Clip holder	P20
Button	S70

Matt

DS8 PSM-S

Cap	M07
Barrel	M07
Clip	S70
Clip holder	P07
Button	S70

Matt

DS8 PSM-S

Cap	M58
Barrel	M58
Clip	S70
Clip holder	P58
Button	S70

DS8
Metal
clip

DS9

DNA

Cases



DS8
Metal
clip

Polished

DS8 PSP-S

Cap	P02
Barrel	P02
Clip	S80
Clip holder	P02
Button	S80

Polished

DS8 MSP-S

Cap	P55
Barrel	P55
Clip	S70
Clip holder	P55
Button	S70

Soft touch

DS8 PSR-S

Cap	R21
Barrel	R21
Clip	S70
Clip holder	P21
Button	S70



Soft touch

DS8 PSR-S

Cap	R28
Barrel	R28
Clip	S75
Clip holder	P28
Button	S75

Soft touch

DS8 PSR-S

Cap	R70
Barrel	R70
Clip	S75
Clip holder	P70
Button	S75

Soft touch

DS8 PSR-S

Cap	R75
Barrel	R75
Clip	S80
Clip holder	P58
Button	S80

DS8
Metal
clip

DS9

DNA

Cases

DS9

Its form varies from the roundness of the tip to the oval-shaped push button. The large printing surface on the clip, vivid colour range and high-quality Mix & Match options provide lots of opportunity for creative individualization.

[deu] Seine Form wandelt sich vom Rund der Spitze zum Oval des Druckknopfs. Die grosse Druckfläche auf dem Clip, starke Farbwelten und wertige Mix & Match Optionen bieten viel kreativen Raum für seine Individualisierung.

[fra] Sa forme, ronde à l'extrémité, devient ovale au niveau du bouton-poussoir. Une large surface d'impression sur l'agrafe, une vaste gamme de couleurs, ainsi que des options Mix & Match de qualité permettent de donner libre cours à sa propre créativité dans la personnalisation.

[esp] Su forma se transforma desde su punta redonda hasta su botón de presión oval. La amplia superficie de impresión sobre el clip, los potentes mundos cromáticos y las opciones de alta calidad Mix & Match dejan mucho margen a la creatividad para su personalización.

[ita] La forma cambia dallo sferico del puntale all'ovale del pulsante. L'ampia superficie di stampa sulla clip, la straordinaria varietà di colori e le prestigiose opzioni Mix & Match permettono di dar libero sfogo alla creatività di personalizzazione.

[rus] Её форма перетекает из круга наконечника в овал кнопки. Поверхности клипа и кнопки отделены от корпуса. Большая поверхность под нанесение печати на клипсе, выразительные цвета и многочисленные варианты комбинирования обеспечивают широкий простор для творческой индивидуализации.



The Promotional Gift
Award Winner



DS9

DNA

Cases

Product code

DS9	P	M	M	-	P	P
-----	---	---	---	---	---	---

① ② ③ ④ ⑤

① Writing system

P Push ball pen



② Cap

M Matt



③ Barrel

M Matt



④ Button

P Polished



⑤ Ring

P Polished

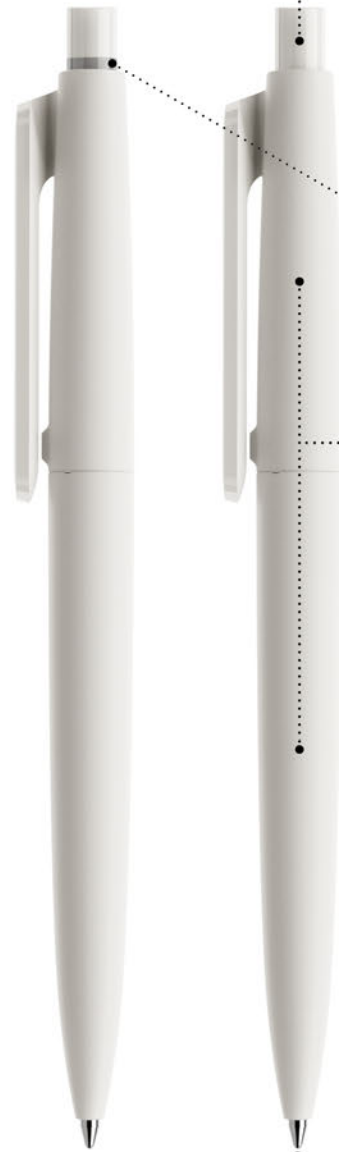

Refills

Standard Floating Ball® lead free 1.0 mm
All Prodir pens are refillable. Discover other options on page 168.

Button

Polished



Ring option

Polished



Cap and barrel

Matt
(with
polished
clip)



Designer's choice (Starting from 5.000 pieces)

Cap and barrel
Matt



M37

Button
Polished



P37

New surface and colours!

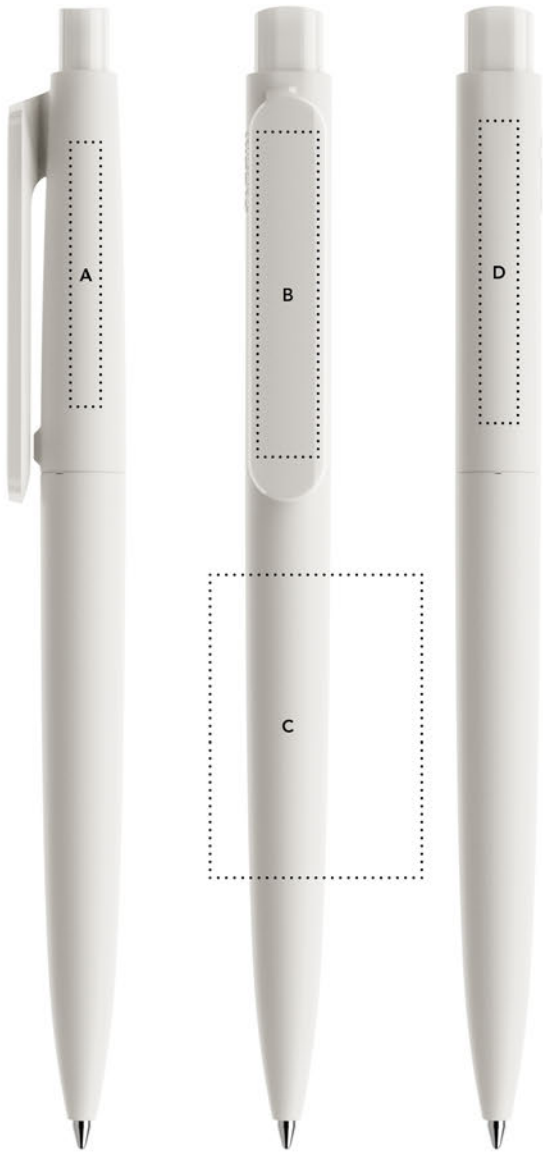

DS9

Print areas

		mm	Inch	Print	Notes
A	Side cap	35 x 4	1,38 x 0,16	1 colour	-
B	Clip	43 x 8	1,70 x 0,31	6 colours	-
C	Body	40 x 28	1,58 x 1,10	4 colours	-
D	Back cap	40 x 5	1,57" x 0,20	1 colour	-



Matt

DS9 PMM-P

Cap	M02
Barrel	M02
Button	P02

Matt

DS9 PMM-P

Cap	M05
Barrel	M05
Button	P05

Matt

DS9 PMM-PP

Cap	M60
Barrel	M60
Button	P60
Ring	P20



Matt

DS9 PMM-P

Cap	M02
Barrel	M13
Button	P13

Matt

DS9 PMM-P

Cap	M49
Barrel	M49
Button	P49

Matt

DS9 PMM-PP

Cap	M61
Barrel	M61
Button	P61
Ring	P13



Matt

DS9 PMM-P

Cap	M75
Barrel	M75
Button	P75

Matt

DS9 PMM-P

Cap	M70
Barrel	M70
Button	P02

Matt

DS9 PMM-P

Cap	M02
Barrel	M02
Button	P02

DNA Identity Pen

Never before has there been so much individuality: A range of colours, surfaces and three-dimensional patterns, materials like wood and metal, multi-coloured printing – the entire DNA of a brand can be assembled with the individually combinable modules of the DNA Identity Pen to generate an unmistakable image. Now with fresh colours and new, bold 3D surfaces.

[deu] So viel Individualität war noch nie: Verschiedene Farben, Oberflächen und dreidimensionale Pattern, Materialien wie Holz und Metall, mehrfarbige Aufdrucke – die gesamte DNA einer Marke lässt sich mit den individuell kombinierbaren Modulen des DNA Identity Pen zu einem unverwechselbaren Bild zusammenfügen. Jetzt mit frischen Farben und neuen starken 3D-Oberflächen.

[fra] Jamais l'individualité n'avait atteint un tel niveau : diversité des couleurs, des surfaces et motifs tridimensionnels, des matériaux tels que le bois et le métal, impressions en plusieurs couleurs – l'ADN d'une marque peut être associé aux modules, individuellement combinables, du DNA Identity Pen pour créer une image unique. Désormais avec des couleurs fraîches et de nouvelles surfaces 3D fortes.

[esp] Nunca ha habido tanta individualidad: distintos colores, superficies y diversos motivos tridimensionales, materiales como madera y metal, impresiones en varios colores; ya es posible reproducir todo el ADN de una marca combinando los módulos individuales del DNA Identity Pen para formar una imagen inconfundible. Ahora con colores frescos y nuevas fuertes superficies en 3D.

[ita] La personalizzazione non aveva mai raggiunto questi livelli. Varietà di colori e superfici, disegni tridimensionali, materiali come legno e metallo, stampe multicolore: il DNA di un marchio prende forma in un'immagine inconfondibile grazie ai moduli combinabili della DNA Identity Pen. Ora disponibile con colori freschi e nuove vivaci superfici 3D.

[rus] Такого уровня индивидуализации еще не было: разные цвета, поверхности и трехмерные узоры, материалы (древесина и металл), разноцветная печать – с помощью индивидуально комбинируемых модулей DNA Identity Pen всю ДНК бренда можно воплотить в одном неповторимом образе. Теперь со свежими расцветками и новыми первоклассными трехмерными поверхностями.



The Promotional Gift
Award Winner



DNA

Cases

Product code



① ② ③ ④

① Writing system

P Push ball pen



② Clip

P Polished



③ Nose cone

P Polished
S Satin finish metal
C Chrome finish metal



④ Button

P Polished
S Satin finish metal
C Chrome finish metal



Modules surfaces

Modules A

P-DO Polished dot pattern
M Matt
M-DI Matt diamond pattern
R Soft touch
R-DO Soft touch dot pattern
R-DI Soft touch diamond pattern

Modules B

P Polished
W Wood
S Satin finish metal
C Chrome finish metal

Modules C

P-DO Polished dot pattern
M Matt
M-LI Matt Line pattern
R Soft touch
R-DO Soft touch dot pattern
R-LI Soft touch line pattern

Modules D

P Polished
T Transparent
W Wood
S Satin finish metal
C Chrome finish metal

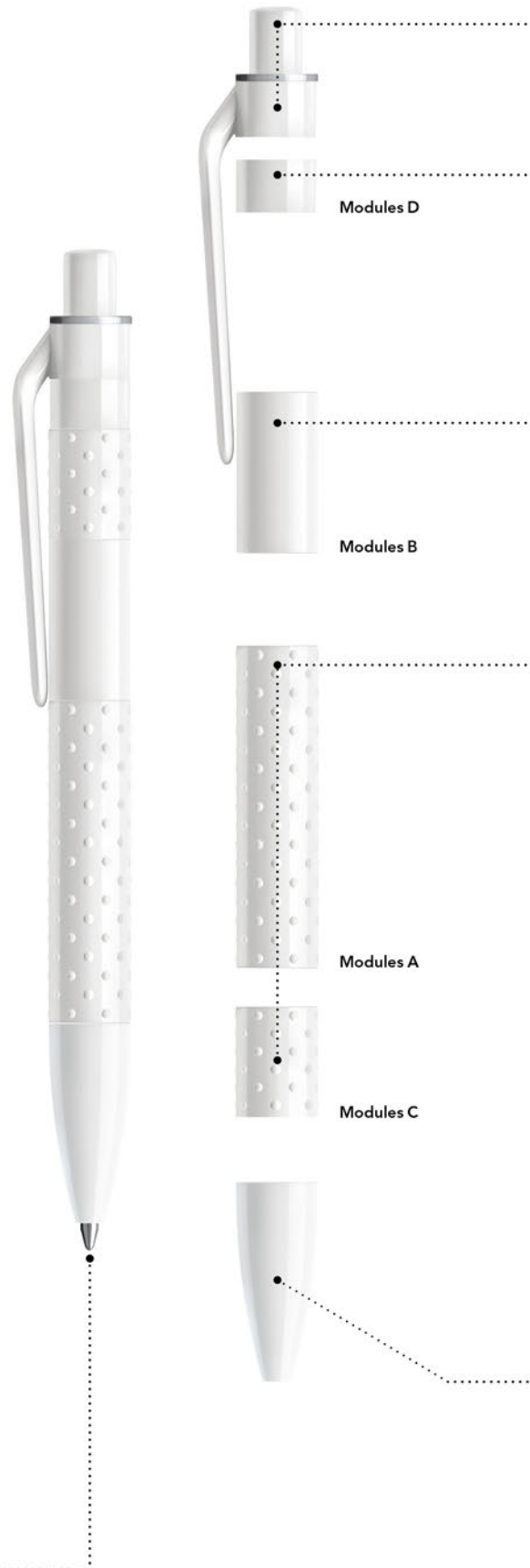

Refills

Standard Floating Ball® lead free 1.0 mm
All Prodir pens are refillable. Discover other options on page 168.

Clip and button



Metal button



Modules D



Modules B

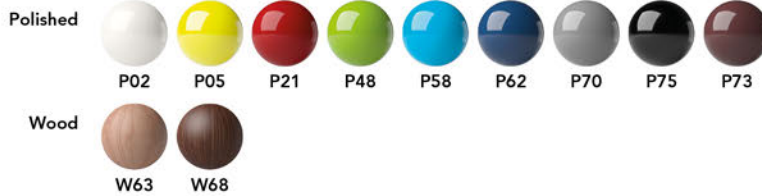

Modules A and C



Nose cone



Make it simple: Configure your DNA Identity Pen at dna.prodir.com

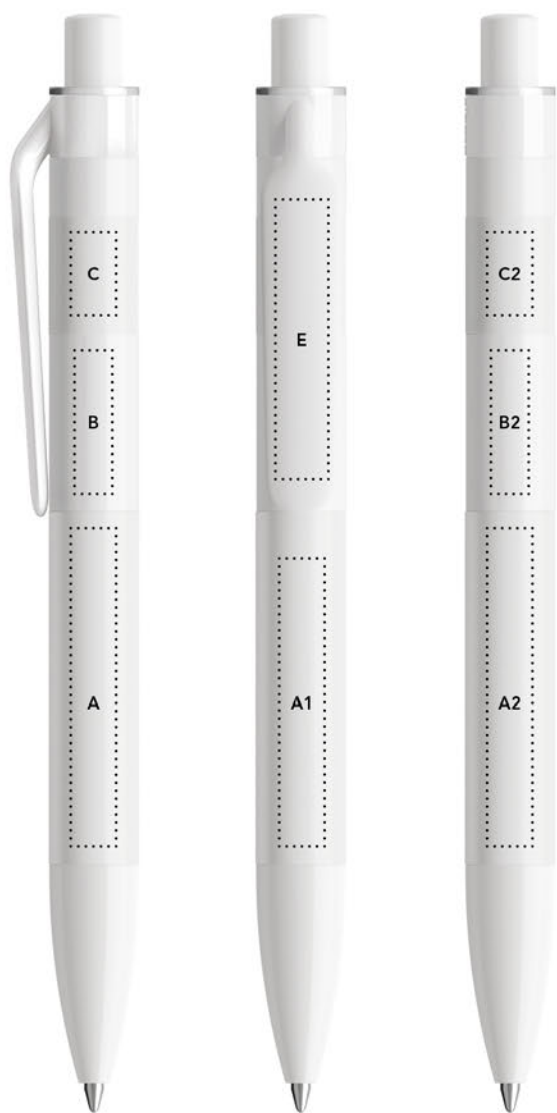

Print areas

		mm	Inch	Print	Notes
A	Modules A	42 × 6	1,65 × 0,24	1 colour	-
A1	Modules A	38 × 6	1,50 × 0,24	6 colours	Soft touch version 1 colour
A2	Modules A	42 × 6	1,65 × 0,24	6 colours	Soft touch version 1 colour
B	Modules B	19 × 5	0,75 × 0,20	1 colour	Metal version laser engraving
B2	Modules B	19 × 5	0,75 × 0,20	6 colours	Metal version laser engraving
C	Modules C	11 × 6	0,43 × 0,24	1 colour	-
C2	Modules C	11 × 6	0,43 × 0,24	6 colours	Soft touch version 1 colour
E	Clip	37 × 7	1,46 × 0,28	6 colours	-

[eng]

What's possible

Versions

BASIC DNA

In this basic version, the DNA Identity Pen comprises 4 modules (A + B + C + D) of various sizes, materials, surfaces and colours. The modules can be arranged in any order you wish.

FREE DNA (PZZ)

In this version, you can individually assemble your DNA Identity Pen: a FREE DNA comprises at least 2 and maximum 12 modules in various sizes, materials, surfaces and colours (e.g. A + B + B). The modules can be arranged in any order you wish.

Module Groups

Modules A

- The Pattern Module of Group A, also with Soft touch finish, cannot be printed.
- With the other modules of this group in Soft touch as well as modules with matt surfaces, the right side and the reverse side can be printed. The front side can also be printed, however, for technical reasons, the module must be positioned in connection with the tip.

Modules B

- The Wood Module of Group B cannot be personalized.
- The Metal module can be personalized with laser engraving.
- The Polished module can be printed on the right side and on the reverse side. The front side cannot be personalized.

Modules C

- The Pattern Module of Group C, also with Soft touch finish, cannot be printed.
- With the other modules of this group in Soft touch as well as modules with matt surfaces, the right side and the reverse side can be printed. The front side for these modules of Group C cannot be printed.

Modules D

- The modules of this group cannot be personalized.

Wood Modules

Owing to its natural characteristics, each module is unique due to individual wood grain and colour nuances. The images are therefore only intended for purposes of orientation and are non-binding.

[deu]

Machbares

Ausführungen

BASIC DNA

In dieser Basisversion umfasst der DNA Identity Pen 4 Module (A + B + C + D) aus unterschiedlichen Größen, Materialien, Oberflächen und Farben. Die Module lassen sich in beliebiger Reihenfolge anordnen.

FREE DNA (PZZ)

In dieser Version können Sie sich Ihren DNA Identity Pen individuell zusammensetzen: Ein FREE DNA besteht aus mindestens 2 und maximal 12 Modulen in verschiedenen Größen, Materialien, Oberflächen und Farben (z.B. A + B + B). Die Module lassen sich in beliebiger Reihenfolge anordnen.

Modul-Gruppen

Module A

- Die Pattern Module der Gruppe A, auch die mit Soft touch Veredelung, lassen sich nicht bedrucken.
- Bei den anderen Modulen dieser Gruppe in Soft touch sowie Modulen mit matter Oberfläche können Sie die rechte Seite und die Rückseite bedrucken. Auch die Vorderseite ist bedruckbar, dazu muss das Modul allerdings aus produktionstechnischen Gründen im Anschluss an die Spitze positioniert werden.

Module B

- Das Holzmodul der Gruppe B ist nicht personalisierbar.
- Das Metallmodul lässt sich mit Lasergravur personalisieren.
- Das polierte Modul kann auf der rechten Seite und auf der Rückseite bedruckt werden. Seine Vorderseite ist nicht personalisierbar.

Module C

- Die Pattern Module der Gruppe C, auch die mit Soft touch Veredelung, lassen sich nicht bedrucken.
- Bei den anderen Modulen dieser Gruppe in Soft touch sowie Modulen mit matter Oberfläche können Sie die rechte Seite und die Rückseite bedrucken. Die Vorderseite ist für diese Module der Gruppe C nicht bedruckbar.

Module D

- Die Module dieser Gruppe lassen sich nicht personalisieren.

Holzmodule

Angesichts seiner natürlichen Beschaffenheit ist jedes Modul ein Einzelstück mit individueller Maserung und Farbnuance. Die Abbildungen dienen daher nur der Orientierung und sind nicht verbindlich.

[fra]

Faisable

Modèles

BASIC DNA

Dans cette version de base, le DNA Identity Pen comprend 4 modules (A + B + C + D) de différentes tailles, matériaux, surfaces et couleurs. Les modules peuvent être disposés dans n'importe quel ordre.

FREE DNA (PZZ)

Dans cette version, vous pouvez configurer individuellement votre DNA Identity Pen : un FREE DNA se compose d'au moins 2 et d'au plus 12 modules de différentes tailles, matériaux, surfaces et couleurs (par ex. A + B + B). Les modules peuvent être disposés dans n'importe quel ordre.

Groupes de modules

Modules A

- Les modules de motifs du groupe A, y compris ceux avec finition Soft touch, ne peuvent pas être imprimés.
- Pour les autres modules de ce groupe en Soft touch ainsi que pour les modules à surface mate, vous pouvez imprimer sur le côté droit et au dos. La face avant peut également être imprimée, mais pour des raisons de production, le module doit être positionné près de sur l'embout.

Modules B

- Le module en bois du groupe B ne peut pas être personnalisé.
- Le module en métal peut être personnalisé par gravure laser.
- Le module poli peut être imprimé sur le côté droit et à l'arrière. Sa face avant ne peut pas être personnalisée.

Modules C

- Les modules de motifs du groupe C, y compris ceux avec finition Soft touch, ne peuvent pas être imprimés.
- Pour les autres modules de ce groupe en Soft touch ainsi que pour les modules à surface mate, vous pouvez imprimer sur le côté droit et au dos. La face avant n'est pas imprimable pour ces modules du groupe C.

Modules D

- Les modules de ce groupe ne peuvent pas être personnalisés.

Modules en bois

En raison de sa texture naturelle, chaque module est une pièce unique avec veinure et teinte individuelles. Les illustrations n'ont donc qu'une valeur indicative et ne sont pas contractuelles.

Make it simple: Configure your DNA Identity Pen at dna.prodir.com

[esp]

Posibilidades

Variantes

BASIC DNA

Esta versión básica del DNA Identity Pen abarca 4 módulos (A + B + C + D) de distintos tamaños, materiales, superficies y colores. Los módulos se pueden colocar en cualquier orden.

FREE DNA (PZZ)

Esta versión le permite configurar su DNA Identity Pen de forma individual: Un FREE DNA está formado como mínimo de 2 y como máximo de 12 módulos de distintos tamaños, materiales, superficies y colores (p. ej. A + B + B). Los módulos se pueden colocar en cualquier orden.

Grupos de módulos

Módulos A

- Los motivos de los módulos del grupo A, incluidos los de acabado Soft touch, no se pueden imprimir.
- En el resto de los módulos de este grupo con Soft touch, así como los módulos con superficie mate, se puede imprimir el lateral derecho y la parte trasera. La parte delantera también se puede imprimir, pero en tal caso es necesario colocar el módulo tras la punta por motivos de fabricación.

Módulos B

- El módulo de madera del grupo B no se puede personalizar.
- El módulo de metal se puede personalizar con un grabado por láser.
- El módulo pulido se puede imprimir en el lateral derecho y en la parte posterior. La parte delantera no se puede personalizar.

Módulos C

- Los motivos de los módulos del grupo C, incluidos los de acabado Soft touch, no se pueden imprimir.
- En el resto de los módulos de este grupo con Soft touch, así como los módulos con superficie mate, se puede imprimir el lateral derecho y la parte posterior. La parte delantera de este módulo del grupo C no se puede imprimir.

Módulos D

- Los módulos de este grupo no se pueden personalizar.

Módulos de madera

Por sus propiedades naturales, cada módulo es una pieza única con vetas y tonalidades individuales. Por ello, las imágenes son meramente indicativas y no son vinculantes.

[ita]

Possibilità

Versioni

BASIC DNA

In questa versione la DNA Identity Pen comprende 4 moduli (A + B + C + D) di diverse dimensioni, materiali, finiture e colori. I moduli possono essere organizzati in qualsiasi ordine.

FREE DNA (PZZ)

In questa versione, è possibile assemblare DNA Identity Pen come si desidera: una «Free DNA» è composta da un minimo di 2 ad un massimo di 12 moduli che possono essere diversi per dimensioni, materiali, finiture e colori (ad esempio, A + B + B). I moduli possono essere organizzati in qualsiasi ordine.

Gruppi di moduli

Moduli A

- I moduli del gruppo A con finitura pattern e pattern Soft touch non possono essere personalizzati.
- I moduli del gruppo A con finitura Matt o Soft touch possono essere personalizzati sul lato destro e sul retro. Può essere personalizzato anche il fronte dei moduli, solo se posizionati come primo modulo vicino al nose cone.

Moduli B

- I moduli del gruppo B in legno non possono essere personalizzati.
- I moduli del gruppo B in metallo possono essere personalizzati con incisione laser.
- I moduli del gruppo B con finitura polished possono essere personalizzati sul lato destro e sul retro. Il fronte non è personalizzabile.

Moduli C

- I moduli del gruppo C con finitura pattern e pattern Soft touch non possono essere personalizzati.
- I moduli del gruppo C con finitura Matt o Soft touch possono essere personalizzati sul lato destro e sul retro. Il fronte non è personalizzabile.

Moduli D

- I moduli del gruppo D non possono essere personalizzati.

Moduli in legno

Data la loro origine naturale, ogni modulo in legno è un pezzo unico, caratterizzato da sfumature di colore e venatura propria. Le illustrazioni sono solo di riferimento e non sono vincolanti della resa effettiva.

[rus]

Возможности

Варианты исполнения

BASIC DNA

В этой базовой версии ручки DNA Identity Pen состоит из 4 модулей (A + B + C + D) разного размера, из разных материалов, с разными поверхностями и разного цвета. Модули могут располагаться в любой последовательности.

FREE DNA (PZZ)

В этой версии вы можете составить свой индивидуальный вариант ручки DNA Identity Pen: FREE DNA состоит минимум из 2 и максимум из 12 модулей разного размера, из разных материалов, с разными поверхностями и разного цвета (например, A + B + B). Модули могут располагаться в любой последовательности.

Группы модулей

Модулей А

- Для фактурных модулей группы А, в том числе с покрытием Soft touch, не предусмотрена возможность печати.
- В других модулях этой группы с покрытием Soft touch, а также с матовой поверхностью печать может наноситься с правой стороны и с обратной стороны. Печать может наноситься и на переднюю сторону, однако для этого по производственно-техническим причинам модуль должен располагаться вслед за законечником.

Модулей В

- Для деревянного модуля группы В персонализация не предусмотрена.
- Металлический модуль можно оформить индивидуально с помощью лазерной гравировки.
- С правой стороны и с обратной стороны полированного модуля может наноситься печать. С передней стороны персонализация не предусмотрена.

Модулей С

- Для фактурных модулей группы С, в том числе с покрытием Soft touch, не предусмотрена возможность печати.
- В других модулях этой группы с покрытием Soft touch, а также с матовой поверхностью печать может наноситься с правой стороны и с обратной стороны. На переднюю сторону этих модулей группы С печать не наносится.

Модулей D

- Для модулей этой группы персонализация не предусмотрена.

Деревянные модули

С учетом своей естественной структуры каждый модуль является уникальным экземпляром с индивидуальной текстурой и цветовым оттенком. Поэтому изображения служат лишь в качестве примера и могут отличаться от фактического исполнения.

Make it simple: Configure your DNA Identity Pen at dna.prodir.com

© 2018 Apple Corps Ltd. A Beatles™ product.



DNA PPP-P

Clip	P02
Module D	P02
Module A	M02
Module B	P02
Module C	P02-DO
Nose cone	P02
Button	P02

DNA PZZ-S

Clip	P70
Module B	S70
Module A	R70-DO
Module B	P05
Nose cone	S70
Button	S70

DNA PZZ-P

Clip	P02	Nose cone	P05
Module B	P48	Button	P75
Module D	T53		
Module C	M05-LI		
Module D	P73		
Module D	T48		
Module C	R58-LI		
Module C	R75-DO		



DNA PPS-C

Clip	P58
Module A	M58-DI
Module B	P58
Module D	P62
Module C	P58
Nose cone	S70
Button	C70

DNA PPP-P

Clip	P62
Module C	M02
Module D	W63
Module B	P62
Module A	P62-DO
Nose cone	P62
Button	P62

DNA PPS-S

Clip	P73
Module C	R73
Module D	P02
Module B	W63
Module A	R73
Nose cone	S70
Button	S70



DNA PPS-S

Clip	P02
Module D	P75
Module C	M02
Module B	P21
Module A	M02
Nose cone	S70
Button	S70

DNA PPP-C

Clip	P21
Module D	T21
Module B	P21
Module A	R21-DI
Module C	M21-LI
Nose cone	P21
Button	C70

DNA PPP-P

Clip	P75
Module C	M75
Module D	W63
Module B	P48
Module A	M75
Nose cone	P75
Button	P75

PS2 PS4

Packaging, boxes and cases made to reinforce your message.

[deu] Unsere Verpackungen, Schachteln und Etuis für ein Mehr an Kommunikation.

[fra] Nos emballages, boîtes et étuis pour un surplus de communication

[esp] Nuestros envases, cajitas y estuches aportan un extra de comunicación.

[ita] Confezioni, scatole e astucci per ampliare le possibilità di comunicazione.

[rus] Наши упаковки, коробки и футляры для более эффективной коммуникации.



Product code

PS2

Description

Cardboard case 100% recycled
for one writing instrument.

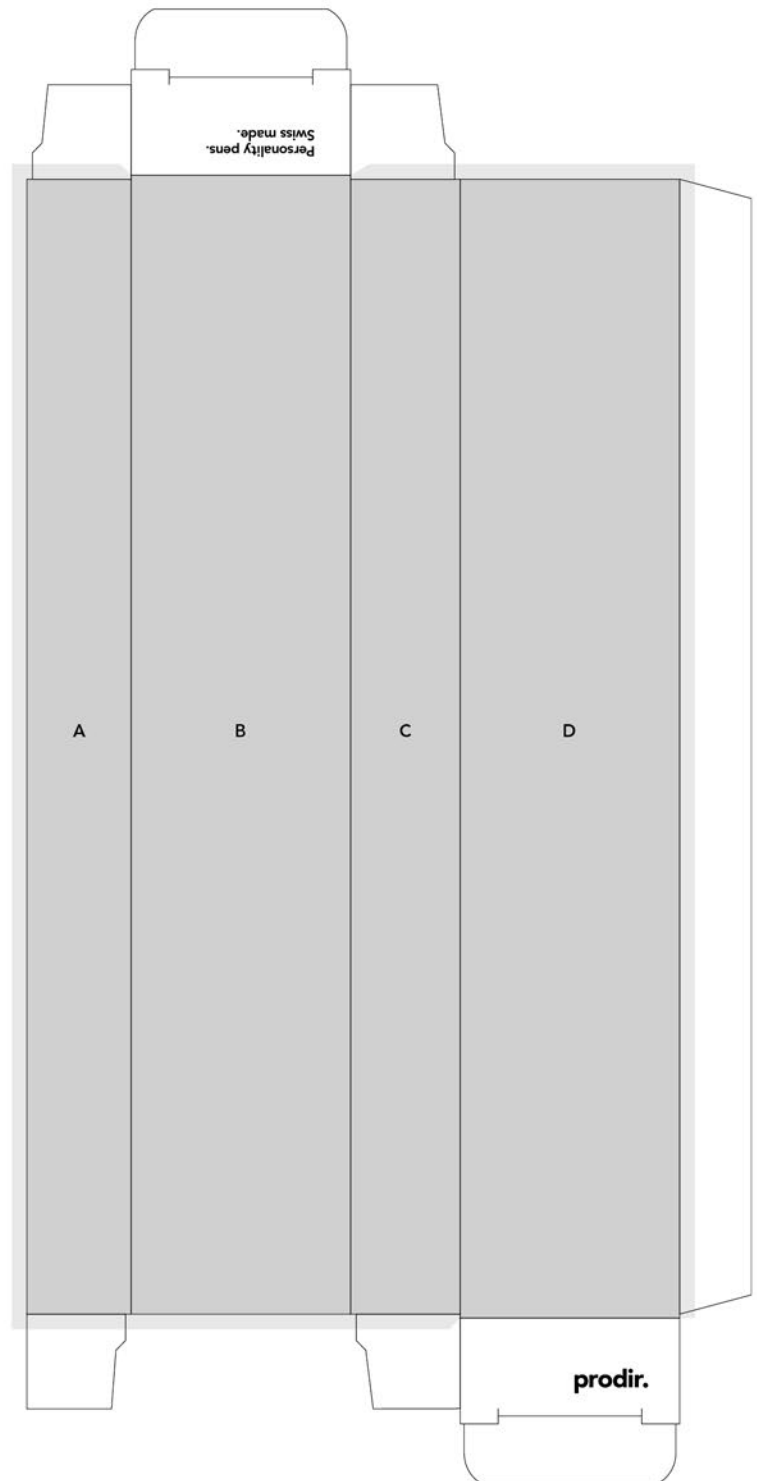

Print areas

		mm	Inch	Print
A	Total	150,5 × 86,3	5,92 × 3,40	Four-colour process (CMYK), plus 3 mm cut on the marked position
	Side	150 × 13,8	5,9 × 0,54	
B	Front	150,6 × 29	5,93 × 1,14	
C	Side	150 × 14,5	5,9 × 0,57	
D	Back	150,6 × 29	5,93 × 1,14	



Product code

PS4

Description

Recycled PET case, not printable.
For one or two writing instruments.



Option: PS4 cardboard sleeve 100% recycled.
Refined cardboard sleeve that covers just a part of the transparent case PS4, leaving the printed clip on display.

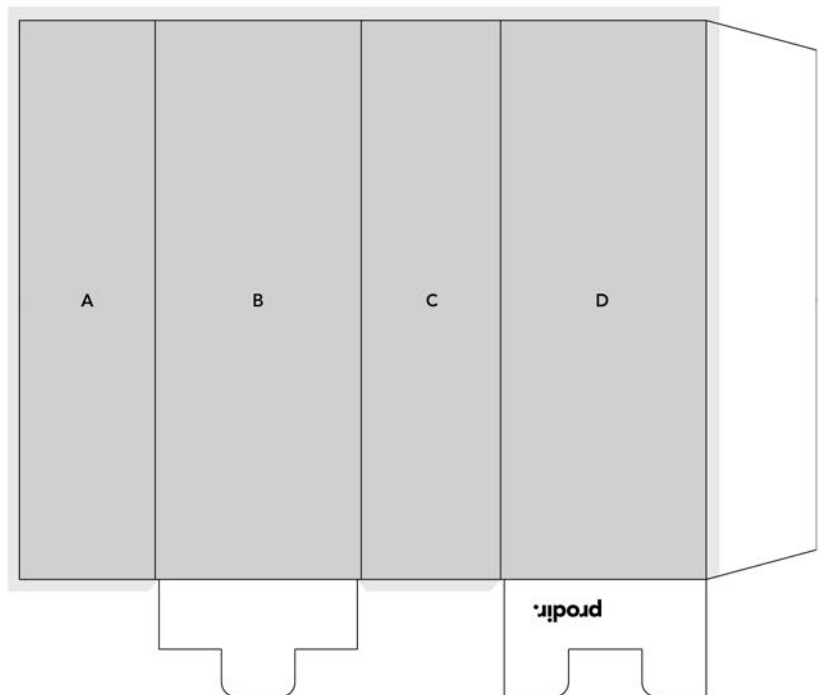

Print areas

		mm	Inch
A	Total	76 x 93	2,99 x 3,66
	Side	76 x 18	2,99 x 0,7
B	Front	76 x 28	2,99 x 1,10
C	Side	76 x 19	2,99 x 0,74
D	Back	76 x 28	2,99 x 1,10

Print

Four-colour process (CMYK), plus 3 mm cut on the marked position



Technical information

- 168-171 Writing systems
- 172-177 Good to know
- 178 Special colours
- 179 Mix & Match
- 180-181 Fastlane
- 182-183 Colour and surface table

Writing systems

[eng]

Writing systems

Our refills deliver top writing comfort and perfect graphic style. We make a point of developing and producing them ourselves, as a writing system can only be as good and reliable as the precisely matched interplay of its components. It is easy to replace used refills for all Prodir models. So you can go on using our writing instruments for a long time - this is what they are designed for.

All DS, QS and DNA models may be ordered with the refills Floating Ball® lead free and Gel lead free. DS3 and DS8 can also be supplied as mechanical pencils.

[deu]

Schreibsysteme

Hoher Schreibkomfort und ein perfektes Schriftbild zeichnen unsere Minen aus. Wir entwickeln und produzieren sie bewusst selbst, weil jedes Schreibsystem nur so gut und zuverlässig ist wie das genau aufeinander abgestimmte Zusammenspiel seiner Komponenten. Verbrauchte Minen lassen sich bei allen Prodir Modellen problemlos austauschen. Damit Sie lange weiterschreiben können, denn dafür sind unsere Schreibgeräte ausgelegt.

DS, QS und DNA Modelle sind mit den Minen Floating Ball® lead free und Gel lead free erhältlich. DS3 und DS8 können auch als Druckbleistift geliefert werden.

[fra]

Systèmes d'écriture

Un confort d'écriture élevée et un tracé parfait caractérisent nos recharges. Nous les développons et les produisons volontairement nous-mêmes car la qualité et la fiabilité d'un instrument d'écriture dépendent de l'harmonie précise entre ses différents éléments. Une fois épuisées, les recharges peuvent être remplacées, sur tous les modèles Prodir. Afin que vous puissiez continuer à écrire longtemps, ce pourquoi nos instruments d'écriture ont été conçus.

Toutes nos références DS, QS et DNA sont rechargeables en Floating Ball® lead free et Gel lead free. Le DS3 et le DS8 sont également disponibles sous la forme d'un porte-mine.

[esp]

Sistemas de escritura

Una gran comodidad al escribir y una escritura perfecta son lo que caracteriza a nuestras minas. Las desarrollamos y las producimos nosotros mismos, fruto de una decisión plenamente consciente, porque cada sistema de escritura solamente puede ser tan bueno y tan fiable como lo sea la combinación perfectamente coordinada de sus componentes. Las minas gastadas se pueden cambiar sin problema en todos los modelos Prodir. Para que usted pueda continuar escribiendo por mucho tiempo, pues para eso están diseñados nuestros instrumentos de escritura.

Para todos los modelos DS, QS y DNA es posible pedir minas Floating Ball® lead free y Gel lead free. El DS3 y el DS8 también están disponibles como portaminas.

[ita]

Sistemi di scrittura

I nostri refill si distinguono per un elevato comfort di scrittura e un tratto perfetto. Non a caso li progettiamo e realizziamo direttamente, perché ogni sistema funziona ed è affidabile solo grazie al perfetto connubio tra i singoli componenti. I refill esauriti si possono sostituire senza problemi in tutti i modelli Prodir. Così potrai scrivere a lungo, perché i nostri strumenti di scrittura sono progettati per questo.

In tutti i modelli DS, QS e DNA è possibile utilizzare refill Floating Ball® lead free e Gel lead free. La DS3 e la DS8 sono disponibili anche come portamine.

[rus]

Системы письма

Наши стержни отличаются максимальным комфортом при письме и превосходным характером письма. Мы специально сами разрабатываем и производим их, ведь любая система письма хороша и надежна лишь настолько, насколько слаженным является взаимодействие ее компонентов. Используемые стержни во всех моделях Prodir можно без проблем заменить, чтобы продолжить писать, ведь именно для этого и предназначены наши письменные приборы.

Модели DS, QS и DNA можно заказать на выбор со стержнем Floating ball® lead free или целевым. DS3 и DS8 также выпускаются в виде механического карандаша.

Standard

Floating Ball® 1.0 mm lead free



Floating Ball® 1.0 mm lead free black casing



Options

Floating Ball® 1.4 mm lead free



Floating Ball® 1.4 mm lead free black casing



Floating Ball® 1.0 mm lead free



Gel SuperDry® 0.7 mm lead free



Gel Asia 0.5 mm lead free



HB lead 0.7 mm



[eng]

Ballpoint Pens

Floating Ball® lead free

The standard refill for a consistent graphic style and long-term writing pleasure.

High-quality plastic jumbo refill with 1.0 mm carbide writing ball in innovative tip made from lead free, stainless steel, filled with medium viscosity ink paste, available in the writing colours Blue or Black, waterproof, and in compliance with the ISO standard 12757-1/2.

Refill compliant with the European REACH 1907/2006 regulation and it contains no elements on the SVHC list (Substances of Very High Concern) and its annexes.

Options

- Large-capacity metal refill for even higher writing performance and more heft
- 1.4 mm tip for a slightly wider line and an even more gentle writing feeling
- Red available on request

Gel pens

Gel SuperDry® lead free

Quicker-drying than traditional gel refills, smooth writing experience, consistent lines and precise graphic style.

Plastic refill with 0.7 mm tungsten carbide ball in an anti-corrosion stainless steel tip, water-based ink, Blue or Black, ISO 27668-1.

Gel Asia lead free

Gel refill with extra-fine tip and pigmented ink, smooth writing experience, consistent lines and precise graphic style, ideal for Asian writing styles.

Plastic refill with extra-fine 0.5 mm tungsten carbide ball in an anti-corrosion stainless steel tip, water-based pigmented ink, Blue and Black, ISO 27668-1/2, documentary proof.

Mechanical pencils

Mechanical pencil with integral eraser

Robust double-push mechanism with retractable stainless steel tip, medium hard 0.7 mm HB lead. Available as an option for DS3 and DS8 models.

[deu]

Kugelschreiber

Floating Ball® lead free

Standardmine für ein gleichmässiges Schriftbild und langen Schreibgenuss.

Die hochwertige Kunststoff-Grossraummine mit 1.0 mm Karbid-Kugel in innovativer Spitze aus bleifreiem, nicht rostendem Stahl, gefüllt mit Tintenpaste mittlerer Viskosität, ist in den Schreibfarben Blau oder Schwarz lieferbar. Entspricht den ISO Normen 12757-1/2, dokumentenecht.

Die Mine genügt der Europäischen REACH Verordnung 1907/2006 und enthält keine Elemente der SVHC Liste (Substance of Very High Concern) und ihrer Anhänge.

Optionen

- Metall-Grossraummine für noch mehr Schreibleistung, höheres Gewicht
- 1.4 mm Spitze für eine leicht breitere Linienführung und ein noch weicherer Schreibgefühl
- Schreibfarben Rot auf Anfrage

Gelschreiber

Gel SuperDry® lead free

Schneller trocknend als herkömmliche Gel-Minen, gleitendes Schreibgefühl, konstante Linienführung und intensives Schriftbild.

Kunststoff-Mine mit 0.7 mm Wolframcarbid-Kugel in korrosionsresistenter Edelstahlschmelze, wasserbasierte Tinte, Schreibfarben Blau oder Schwarz, ISO Norm 27668-1.

Gel Asia lead free

Gel-Mine mit extrafeiner Spitze und pigmentierter Tinte, gleitendes Gel-Schreibgefühl, konstante Linienführung und intensives Schriftbild, ideal für asiatische Schreibgewohnheiten.

Kunststoff-Mine mit extrafeiner 0.5 mm Wolframcarbid-Kugel in korrosionsresistenter Edelstahlschmelze, pigmentierte Tinte auf Wasserbasis, Schreibfarben Blau und Schwarz, ISO Normen 27668-1/2, dokumentenecht.

Druckbleistifte

Mechanischer Bleistift mit integriertem Radiergummi

Stabile Doppeldruckmechanik mit versenkbarer Edelstahlschmelze, mittelharte 0.7 mm HB Mine. Als Option für die Modelle DS3 und DS8.

[fra]

Stylos à bille

Floating Ball® lead free

La recharge standard pour un tracé régulier et un long plaisir d'écriture.

La recharge en plastique, haute capacité, avec bille en carbure de 1,0 mm, logée dans une pointe innovante en acier inoxydable sans plomb, remplie d'encre de viscosité moyenne, est disponible en bleu ou noir et conforme aux normes ISO 12757-1/2, pour utilisation documentaire.

La recharge est conforme au règlement européen REACH 1907/2006 et ne contient aucun élément de la liste SVHC (substances extrêmement préoccupantes) et de ses annexes.

Options

- Recharge métal grande capacité pour une performance d'écriture encore supérieure, poids plus élevé
- Pointe de 1,4 mm pour un tracé légèrement plus large et une sensation d'écriture encore plus douce
- Couleur d'encre rouge sur demande

Stylos gel

Gel SuperDry® lead free

Sèche plus rapidement que les recharges gel courantes, sensation d'écriture très souple, tracé régulier et ligne intense.

Recharge plastique, avec bille 0,7 mm en carbure de tungstène et pointe acier inoxydable résistante à la corrosion, encre à base d'eau, couleurs d'encre bleu et noir, conforme à la norme ISO 27668-1.

Gel Asia lead free

Recharge gel à pointe extra fine, à encre pigmentée, sensation d'écriture très souple du gel, tracé régulier et ligne intense, idéale pour les habitudes d'écriture asiatiques.

Recharge plastique, avec bille extra fine 0,5 mm en carbure de tungstène et pointe acier inoxydable résistante à la corrosion, encre pigmentée à base d'eau, couleurs d'encre bleu et noir, conforme aux normes ISO 27668-1/2, pour utilisation documentaire.

Porte-mine

Porte-mine mécanique avec gomme intégrée

Mécanisme robuste à double pression avec pointe acier inoxydable escamotable, mines de dureté moyenne HB 0,7 mm. En option pour les modèles DS3 et DS8.

[esp]

Bolígrafos

Floating Ball® lead free

La mina estándar que proporciona una escritura uniforme y permite disfrutar escribiendo por mucho tiempo.

La mina de plástico de alta capacidad destaca por su excelente calidad y dispone de una esfera de carburo de 1,0 mm en punta innovadora de acero inoxidable sin plomo, rellena con pasta de tinta de viscosidad media; está disponible en colores de escritura azul o negro y cumple las normas ISO 12757-1/2, tinta indeleble.

La mina cumple los requisitos del Reglamento europeo REACH 1907/2006 y no contiene ninguna sustancia de la lista SVHC (sustancias extremadamente preocupantes) y sus anexos.

Opciones

- Mina de gran capacidad de metal, que tarda más en gastarse y aporta un peso mayor
- Punta de 1,4 mm para una línea algo más ancha y una sensación de escritura aún más suave
- Disponible en tinta roja si así nos lo solicita

Bolígrafos de gel

Gel SuperDry® lead free

Seca más rápidamente que las minas de gel convencionales, sensación deslizante al escribir, trazo constante y escritura intensa.

Mina de plástico con bola de carburo de wolframio de 0,7 mm dentro de una punta de acero fino resistente a la corrosión, tinta a base de agua de color azul o negro, norma ISO 27668-1.

Gel Asia lead free

Mina de gel con punta extrafina y tinta pigmentada, sensación deslizante al escribir con gel, trazo constante e intenso, ideal para la escritura en lenguas asiáticas.

Mina de plástico con bola de carburo de wolframio extrafina de 0,5 mm dentro de una punta de acero fino resistente a la corrosión, tinta pigmentada a base de agua de color azul o negro, normas ISO 27668-1/2, indeleble.

Portaminas

Lápiz mecánico con goma de borrar integrada

Mecanismo de doble presión robusto con punta de acero inoxidable retráctil, mina HB de 0,7 mm de dureza media. Disponible como opción para los modelos DS3 y DS8.

[ita]

Penne a sfera

Floating Ball® lead free

Refill standard per un tratto regolare e un prolungato piacere di scrivere.

Il sofisticato e capiente refill in plastica con sfera in carburo di tungsteno da 1,0 mm in una innovativa punta in acciaio inossidabile senza piombo, riempito con inchiostro di media viscosità, è disponibile in blu o nero ed è indicato per documenti secondo le norme ISO 12757-1/2. Il refill è conforme al regolamento europeo REACH 1907/2006 e non contiene elementi dell'elenco SVHC (Substance of Very High Concern) e allegati.

Opzioni

- Capiente refill in metallo per una durata e un peso maggiori
- Punta da 1,4 mm per un tratto leggermente più spesso e una sensazione di scrittura più morbida
- Inchiostro rosso disponibile su richiesta

Penne gel

Gel SuperDry® lead free

Asciugatura più rapida dei refill gel tradizionali, sensazione di scrittura scorrevole, tratto costante e intenso.

Refill in plastica con sfera in carburo di tungsteno da 0,7 mm in una punta di acciaio inox resistente alla corrosione, inchiostro a base d'acqua, disponibile in blu o nero, normativa ISO 27668-1.

Gel Asia lead free

Refill gel con punta ultrasottile e inchiostro pigmentato, scorrevolezza tipica del gel, tratto costante e intenso, ideale per le consuetudini di scrittura asiatiche.

Refill in plastica con sfera ultrasottile in carburo di tungsteno da 0,5 mm in una punta di acciaio inox resistente alla corrosione, inchiostro pigmentato a base d'acqua, disponibile in blu o nero, indicata per documenti secondo le norme ISO 27668-1/2.

Portamine

Matita meccanica con gomma integrata

Stabile meccanismo a doppia pressione con punta retrattile in acciaio inox, mina HB 0,7 mm di media durezza. Opzione disponibile per i modelli DS3 e DS8.

[rus]

Шариковые ручки

Floating Ball® lead free

Стандартный стержень обеспечивающий равномерный характер письма и длительное наслаждение от письма.

Высококачественный пластмассовый стержень большого объема с карбидным шариком диаметром 1,0 мм в инновационном наконечнике, изготовленном из бесвинцевой нержавеющей стали, с пастой средней вязкости синего или черного цвета соответствует стандартам ISO 12757-1/2 и может использоваться для архивных документов долговременного хранения. Стержень соответствует требованиям регламента Европейского союза REACH 1907/2006 и не содержит элементов, входящих в список особо опасных веществ SVHC (Substance of Very High Concern) и его приложения.

Опции

- Металлический стержень большого объема для еще большей производительности письма, утяжеленный
- Кончик 1,4 мм для более размашистых линий и еще более мягкого письма
- Паста красного цвета по запросу

Гелевые ручки

Gel SuperDry® lead free

Паста впитывается намного быстрее, чем у традиционных гелевых стержней, плавное письмо, непрерывная линия и яркий след. Пластмассовый стержень с шариком из карбида вольфрама диаметром 0,7 мм в коррозионно-стойком наконечнике из высококачественной стали с пастой на водной основе синего или черного цвета, стандарт ISO 27668-1.

Gel Asia lead free

Гелевый стержень с очень тонким кончиком и пигментированной пастой, плавное письмо, непрерывная линия и яркий след, идеальный вариант для письма в азиатском стиле. Пластмассовый стержень с очень маленьким шариком из карбида вольфрама диаметром 0,5 мм в коррозионно-стойком наконечнике из высококачественной стали с пастой на водной основе синего или черного цвета, стандарт ISO 27668-1/2, может использоваться для архивных документов долговременного хранения.

Механический карандаш

Механический карандаш с ластиком

Прочный двойной нажимной механизм с убирающимся наконечником из высококачественной стали, грифель средней твердости диаметром 0,7 мм. В качестве опции для моделей DS3 и DS8.

Good to know

[eng]

Artwork

In order to meet your requirements regarding our DS, QS, DNA and PS products, we need to receive your layout. A digital file of your artwork allows the fastest processing and produces the best results. We can also process material in a printed format.

Vectorised files

- Adobe Illustrator (.ai)
- InDesign (.indd)
- or .eps/.pdf formats generated by these programmes

Please remember to add notes about photographs, pictures and special fonts used in your file.

Bitmap files

- bmp, .tiff, .jpg or .gif format
- Minimum resolution 1:1. 1'200 dpi for lines and text
- Minimum resolution 1:1. 300 dpi for photographs (CMYK) and screened logos

Printed material

- Format 1:2
- Laser prints at a minimum resolution of 600 dpi

Technical design

Upon request, we would be happy to provide you with the respective technical design (.pdf, .eps) for any product. Your graphic designer or agency needs these templates to design the layout.

Design proposals / Layouts

If you currently don't work with a graphic designer or agency, please don't hesitate to contact us. Our graphics will design the products for you – in line with your ideas. In addition to a short written briefing to describe your ideas, you will also need to send us the digital artwork in the best possible quality.

What is possible?

Colours DS, QS & DNA

We can print every colour within the Pantone ("C" colours), HKS ("K" colours) and RAL ranges. Please always specify which colour (reference number for one of the colour scales mentioned above) is to be placed for each position. We print in 5 fluorescent colours too (yellow, green, pink, orange, sunset orange) on P02, M02 and B02 surfaces.

Colours and Font size / Packagings

PS2 boxes and PS4 sleeve option are produced using the classic four-colour process. This technique is particularly suited to the reproduction of images and illustrations. For special requests or requirements, please contact us via telephone or email. We're always glad to help you.

Font size DS, QS & DNA

Fonts should always be vector files (PATH). We generally recommend font sizes starting from 4 pt. The maximum size possible depends on the printable area available.

Stroke weight

The minimum stroke weight and line distance depends on what is technically feasible and legible:

- stroke weight: $\geq 0,1$ mm
- line distance: $\geq 0,1$ mm

Laser engraving

Available for QS metal clips, DS8 metal clip and the B-modules of the DNA Identity Pen.

Designer's choice

Minimum order quantity of 5.000 writing instruments according to standard price list. Only available at these conditions in the configuration selected by the designer.

Approval of production proof

Production proof

As soon as we receive your printing details, we will send you an e-mail showing colours, position and print size. Please check all information thoroughly. If you are satisfied with the result, please send us your approval of the production proof. Upon receipt of this approval we start the production.

Corrections

If you would like to make changes, please send us a detailed email. Please also make sure that corrections are legible. Prior to printing, we will send you by e-mail a new draft with the changes. Once again, you are kindly asked to check the proof and send us your approval.

Additional information

Orders

Please use the full order codes and specify all requirements, e.g. ink colour. This will help to speed up the process.

Products and prices

You will find the order code and volume-dependent unit price of our products in our price lists.

Terms and conditions

Our terms and conditions are outlined in our price lists.

Shipping-Packaging

Our products are packed into bulks of 50/100 pcs each and shipped into cartons for 500/1.000 pcs. Models DS2, DS3.1, DS4, DS5, DS7 and DS9 are packed into Bulk 50's, while DS1, DS3, DS8, and QS are packed into Bulk 100's. In addition to our standard boxes all products can be delivered in different packagings: PS2, PS4 and polybag. The DNA Identity Pen is individually packed in a transparent box made of recycled PET.

Get in touch

Although we are committed to providing you with all necessary information in our catalogue, you may have specific questions that remain unanswered. If you have any queries, please don't hesitate to contact us. By phone, e-mail or visit our website. We look forward to hearing from you.

Gut zu wissen

[deu]

Druckvorlagen

Um DS, QS, DNA und PS Produkte nach Ihren Vorstellungen personalisieren zu können, benötigen wir Druckvorlagen von Ihnen. Digitale Vorlagen garantieren beste Ergebnisse und schnellste Verarbeitung. Gedruckte Vorlagen sind auch möglich.

Vektorisierte Dateien

- Adobe Illustrator (.ai)
- InDesign (.indd)
- oder .eps bzw. .pdf-Formate von diesen Programmen.

Bitte vergessen Sie nicht, Fotos, Bilder und eventuell besondere Schriftsätze mit den entsprechenden Hinweisen Ihrem Ordner beizufügen.

Bitmap Dateien

- .bmp, .tiff, .jpg oder .gif
- Mindestauflösung 1:1. 1.200 dpi für Linien und Texte
- Mindestauflösung 1:1. 300 dpi für Fotos (CMYK) und gerasterte Logos

Drucksachen

- Format 1:2
- Laserausdrucke mit einer Mindestauflösung von 600 dpi

Technisches Datenblatt

Für jedes Produkt stellen wir Ihnen auf Anfrage gern die entsprechenden digitalen (.pdf, .eps) Datenblätter zur Verfügung. Ihre Agentur/Grafiker brauchen diese für die Gestaltung des Layouts.

Gestaltungsvorschläge / Grafik

Sollten Sie mit keinem Grafiker bzw. mit keiner Agentur arbeiten, können Sie sich an uns wenden. Unsere Grafiker gestalten gern die gewünschten Produkte, ganz nach Ihren Vorstellungen. Neben einem kurzen schriftlichen Briefing, in dem Sie uns Ihre Vorstellungen erläutern, benötigen wir dazu digitale Vorlagen in bestmöglicher Qualität.

Machbares

Farben DS, QS und DNA

Wir können jede Farbe der Skalen Pantone ("C" Farben), HKS ("K" Farben) und RAL drucken. Bitte geben Sie bei der Druckvorlage an, welche Farbe (Referenznummer in einer der genannten Farbskalen) wo platziert werden soll. Wir drucken auch 5 Neon-Farben (Gelb, Grün, Pink, Orange, Sunset-Orange) auf den Oberflächen P02, M02 und B02.

Farben und Schriftgrösse / Verpackungen

Die PS2 Boxen und der PS4 Kartonschuber werden in klassischem Vierfarbdruck realisiert. Diese Technik eignet sich besonders für die Wiedergabe von Bildern und Illustrationen. Bei speziellen Anforderungen oder Sonderwünschen wenden Sie sich bitte per Telefon oder Email an uns – wir freuen uns, Ihnen weiterzuhelfen.

Schriftgrösse DS, QS und DNA

Schriftzüge sollten wenn möglich vektorisierte Dateien sein (PATH). Im Regelfall empfehlen wir Buchstabengrößen ab 4 Punkt. Nach oben ist die Buchstabengrösse durch die jeweilige Druckfläche begrenzt.

Strichstärke

Minimale Strichstärke und Liniendistanz werden von den Grenzen des technisch Machbaren und optisch Wahrnehmbaren bestimmt:

- Strichstärke: $\geq 0,1$ mm
- Liniendistanz: $\geq 0,1$ mm

Lasergravur

Machbar auf den Metall-Clips der QS Modelle, dem Metall-Clip des DS8 und auf den B-Modulen des DNA Identity Pen.

Designer's choice

Mindestbestellmenge von 5000 Schreibgeräten nach Standard-Preisliste. Zu diesen Bedingungen nur in der vom Designer ausgewählten Konfiguration lieferbar.

Druckfreigabe

Vorschau

Nach Erhalt Ihrer Druckvorlage schicken wir Ihnen umgehend eine E-Mail, auf denen Farben, Druckstand und Druckgrösse genau zu erkennen sind. Bitte prüfen Sie alle hier gemachten Angaben. Wenn alles zu Ihrer Zufriedenheit ist, geben Sie uns bitte so schnell wie möglich Ihre Freigabe zum Druck – wir starten dann umgehend die Produktion.

Korrekturen

Sollten Sie Korrekturen wünschen, informieren Sie uns bitte im Detail per E-Mail. Zur endgültigen Freigabe erhalten Sie nochmals eine neue Druckfreigabe per E-Mail mit allen Änderungen. Auch hier gilt: Je früher wir grünes Licht von Ihnen bekommen, desto schneller können wir mit der Produktion beginnen.

Weitere Informationen

Aufträge

Bitte verwenden Sie die vollständigen Bestell-Codes und präzisieren Sie alle gewünschten Details, z.B. die Schreibfarbe. So helfen Sie uns, Ihren Auftrag so schnell wie möglich abzuwickeln.

Produkte und Preise

Die Bestell-Codes und mengenabhängigen Stückpreise unserer Produkte finden Sie in unseren Preislisten.

Liefer- und Zahlungsbedingungen

Unsere Allgemeinen Geschäftsbedingungen finden Sie in unseren Preislisten.

Versand-Verpackung

All unsere Produkte werden in kleinen Schachteln zu 50/100 Stück verpackt und anschliessend in Umkartons zu 500/1.000 Stück. Die Modelle DS2, DS3.1, DS4, DS5, DS7 und DS9 werden in Schachteln zu 50 Stück verpackt, die Modelle DS1, DS3, DS8, und QS zu je 100 Stück. Zusätzlich zu diesen Standardverpackungen können unsere Produkte in alternativen Verpackungen konfektioniert werden: PS2 und PS4. Der DNA Identity Pen wird einzeln in einem transparenten aus recyceltem PET hergestellten Etui verpackt. Details und Kosten sind der Preisliste zu entnehmen.

Kontaktieren Sie uns

Obwohl wir uns bemühen, alle Informationen klar aufzubereiten, kann unser Katalog vielleicht nicht alle Fragen beantworten. Rufen Sie uns gern an, besuchen Sie uns im Internet, schicken Sie uns eine E-Mail, wenn noch etwas offen sein sollte. Wir freuen uns, von Ihnen zu hören.

Bon à savoir

[fra]

Maquettes d'imprimerie

Afin de pouvoir personnaliser vos accessoires d'écriture DS, QS, DNA et PS exactement selon vos conceptions, nous avons besoin de vos maquettes d'imprimerie. Des maquettes numérisées garantissent les meilleurs résultats et le traitement le plus rapide. Mais nous pouvons également travailler avec des modèles imprimés.

Fichiers vectoriels

- Adobe Illustrator (.ai)
 - InDesign (.indd)
 - ou bien formats .eps ou .pdf de ces programmes.
- N'oubliez pas s.v.p. d'ajouter à votre dossier avec les indications correspondantes des photos, des illustrations et des polices.

Fichiers bitmap

- Formats .bmp, .tiff, .jpg ou .gif
- Résolution minimale 1:1. 1200 dpi pour les lignes et les textes
- Résolution minimale 1:1. 300 dpi pour les photographies (CMYK) et les logos tramés

Imprimés

- Format 1:2
- Imprimés au laser avec une résolution minimale de 600 dpi

Fiche technique

Pour tous les produits nous vous fournissons volontiers une fiche technique (.pdf, .eps) correspondant. Votre graphiste ou votre agence a besoin de ce modèle pour la réalisation de la maquette.

Propositions de maquettes / Conception graphique

Si vous ne disposez pas d'un graphiste ou ne collaborez pas avec une agence, vous pouvez faire appel à nos services. Nos graphistes réaliseront les maquettes souhaitées. Bien entendu, en entière conformité avec vos idées. En plus des indications écrites où vous expliquez brièvement ce que vous souhaitez, nous avons besoin de documents numériques de la meilleure qualité possible (voir ci-dessus).

Ce qui est faisable

Couleurs DS, QS et DNA

Dans le cadre de ce qui est faisable nous imprimons pour vous toutes couleurs des échelles Pantone (couleurs "C"), HKS (couleurs "K") et RAL. Veuillez s.v.p. toujours indiquer sur la maquette d'imprimerie quelle couleur (numéro de référence dans l'une des échelles de couleurs mentionnées) doit être placée à quel endroit. Nous imprimons aussi 5 couleurs néon (jaune, vert, rosé, orange, sunset orange) sur tous les surfaces P02, M02 et B02.

Couleurs et taille des caractères / Emballages

Les boîtes PS2, l'option carton du PS4 sont réalisées selon le procédé classique d'impression en quadrichromie. Cette technologie s'adapte particulièrement bien à la reproduction d'images et d'illustrations. En cas de requêtes spécifiques ou exceptionnelles, veuillez nous contacter par téléphone ou e-mail. Nous serons heureux de vous aider à résoudre vos problèmes.

Taille des caractères DS, QS et DNA

Les caractères doivent être en format vectorisé (PATH). En règle générale, nous recommandons des tailles de caractères à partir de 4 points. Vers le haut, la taille des caractères est limitée par la surface d'impression offerte par l'accessoire d'écriture du cas considéré.

Épaisseur des traits

Le minimum concernant l'épaisseur des traits et la distance entre les lignes est déterminé par les limites de ce qui est techniquement faisable et perceptible du point de vue optique:

- épaisseur de trait minimale: $\geq 0,1$ mm
- distance entre les lignes: $\geq 0,1$ mm

Gravure laser

Réalisable sur l'agrafes métal du modèles DS8, sur l'agrafes métal du modèles QS et sur les modules B du DNA Identity Pen.

Designer's choice

Commande minimale de 5.000 stylos selon la liste de prix standard. Livraison possible à ces conditions uniquement dans la configuration retenue par le designer.

Autorisation d'impression

Bon à tirer

Dès réception de votre BAT, nous vous adressons un message électronique sur lequel les couleurs, l'emplacement et la taille de l'impression sont exactement visibles. Veuillez s.v.p. vérifier toutes les indications qui sont faites ici et nous donner le plus rapidement possible votre autorisation d'impression. C'est seulement après cela que nous démarrons la production.

Corrections

Au cas où vous souhaiteriez encore d'autres corrections, nous vous prions de nous les détailler par e-mail. Vous recevrez alors encore une fois un message électronique avec les modifications pour une autorisation définitive d'impression.

Informations supplémentaires

Commandes

Nous vous prions de bien vouloir utiliser les codes de commande complets et de préciser tous les détails souhaités, par exemple la couleur de l'encre. Vous nous aidez ainsi à exécuter votre commande le plus rapidement possible.

Produits et prix

Vous trouverez le code de commande et le prix unitaire dépendant de la quantité commandée de nos produits dans notre barème.

Conditions de livraison et de paiement

Vous trouverez nos Conditions Commerciales Générales dans nos barèmes.

Expédition- Emballage

Nos produits sont emballés dans des boîtes de 50 ou 100 pièces et envoyés dans des cartons de 500 ou 1000 pièces. Les modèles DS2, DS3.1, DS4, DS5, DS7 et DS9 sont emballés dans des boîtes de 50 pièces et les modèles DS1, DS3, DS8 et QS dans des boîtes de 100 pièces. En supplément de nos emballages standards, nos produits peuvent être emballés dans suivantes boîtes: PS2, PS4 et Polybag. DNA Identity Pen est emballé individuellement dans une emballage transparente réalisé en PET recyclé.

Nous vous aidons

Bien que nous nous efforcions de préparer clairement toutes les informations, il se peut que notre catalogue ne réponde pas à toutes les questions. Appelez-nous, rendez-nous visite sur Internet, envoyez nous un message électronique si il y a des détails qui ne sont pas encore totalement clair pour vous.

Bueno saberlo

[esp]

Plantillas de impresión

Para poder personalizar sus artículos DS, QS, DNA y PS conforme a sus deseos personales, necesitamos que nos facilite plantillas de impresión. Las plantillas de impresión en formato digital garantizan los mejores resultados y un procesamiento más rápido. También podemos trabajar con plantillas impresas.

Archivos vectorizados

- Adobe Illustrator (.ai)
 - InDesign (.indd)
 - o formatos .eps o .pdf de estos programas.
- Por favor, no olvide adjuntar instrucciones especiales para fotos, ilustraciones y escritura.

Archivos bitmap

- Formatos .bmp, .tiff, .jpg o .gif
- Resolución mínima 1:1. 1.200 dpi para líneas y textos
- Resolución mínima 1:1. 300 dpi para fotos (CMYK) y logotipos reticulados

Impresos

- Formato 1:2
- Impresiones láser con una resolución mínima de 600 dpi

Plantillas

Para todos los productos le facilitaremos si lo desea las Plantillas digitales (.pdf, .eps) correspondientes. Su grafista o su agencia necesitan esta hoja para diseñar el layout.

Diseño técnico / Gráfico

Si no tiene ningún grafista o ninguna agencia, puede dirigirse a nosotros. Nuestros grafistas diseñan los productos deseados. Naturalmente, completamente según sus deseos. Le pediremos un breve resumen escrito en el que nos explique sus ideas, junto a su diseño gráfico de la mejor calidad posible (véase arriba).

Lo realizable

Colores DS, QS y DNA

Podemos imprimir en todos los colores de las escalas Pantone ("C" colores), HKS ("K" colores) y RAL. Indique siempre en la plantilla de impresión qué color (número de referencia en una de las escalas de color indicadas) debe ubicarse y dónde. Nosotros imprimimos también 5 colores fluorescentes (amarillo, verde, rosado, naranja, sunset orange) en las superficies P02, M02 y B02.

Colores y tamaño de letra / Estuches

Las cajas PS2, la capa de cartón del PS4 se realizan en la impresión clásica a cuatro colores. Esta técnica es especialmente idónea para la reproducción de imágenes e ilustraciones. Si existen requisitos o deseos especiales, póngase en contacto con nosotros por teléfono o Email. Nos complacerá poder ayudarle.

Tamaño de letra DS, QS y DNA

Los textos tienen que ser en formato vectorizado (PATH). Normalmente, recomendamos tamaños de letra a partir de 4 puntos. El tamaño de letra máximo está limitado por la superficie impresa del artículo de escritura.

Grosor de línea

El grosor de línea mínimo y la distancia entre líneas están determinados por los límites de lo técnicamente realizable y lo visualmente perceptible:

- grosor de línea: $\geq 0,1$ mm
- distancia entre líneas: $\geq 0,1$ mm

Grabado láser

Es factible con el clip metálico del modelo DS8, QS y los módulos B del DNA Identity Pen.

Designer's choice

Pedido mínimo de 5.000 instrumentos de escritura según la lista de precios estándar. Con estas condiciones solo se pueden suministrar en la configuración seleccionada por el diseñador.

Autorización de la impresión

Apto para imprimir

Después de recibir su plantilla de impresión, le enviaremos un correo electrónico en el que puedan apreciarse claramente los colores, la situación de la impresión y el tamaño de la misma. Por favor, compruebe todos los datos aquí indicados. Si todo es correcto, le rogamos nos envíe con la mayor brevedad posible su autorización para la impresión. Solamente entonces iniciaremos la producción.

Correcciones

Si desee realizar otras correcciones, comuníquenoslas en detalle por correo electrónico. Para la autorización definitiva recibirá nuevamente un correo electrónico con las modificaciones.

Otras informaciones

Pedidos

Utilice siempre el código de pedido completo y precise todos los detalles deseados, por ejemplo, el color de la tinta. De este modo, nos ayudará a gestionar su pedido lo más rápidamente posible.

Productos y precios

En nuestra lista de precios encontrará el código de pedido y el precio unitario de nuestros productos, en función de la cantidad.

Condiciones de suministro y pago

Encontrará nuestras condiciones comerciales generales en nuestras listas de precios.

Envío-Embalaje

Nuestros productos se empaquetan en cajitas de 50/100 unidades y se envían en cajas de 500/1000 unidades. Los modelos DS2, DS3.1, DS4, DS5, DS7 y DS9 se empaquetan en cajitas de 50 unidades, mientras que los modelos DS1, DS3, DS8 y QS se empaquetan en cajitas de 100 unidades. Además de nuestras cajas estándar todos nuestros productos pueden ser enviados en las confecciones: PS2, PS4 y Polybag. DNA Identity Pen se empaqueta individualmente en una caja transparente hecho en PET reciclado.

Seguiremos prestándole servicio

Aunque nos esforcemos por preparar claramente todas las informaciones, quizá nuestro catálogo no responda a todas las preguntas. Llámenos, visítenos en Internet, envíenos un correo electrónico si desea aclarar alguna duda.

Buono a sapersi

[ita]

Progetto di stampa

Per personalizzare i vostri prodotti DS, QS, DNA e PS esattamente secondo le vostre esigenze, abbiamo bisogno dei vostri progetti di stampa. I migliori risultati e la lavorazione più rapida si ottengono con file digitali. Si accettano anche stampati.

File vettoriali

- Adobe Illustrator (.ai)
- InDesign (.indd)
- oppure formati .eps e .pdf di questi programmi. Si prega di non dimenticare di fornire eventuali annotazioni su foto, immagini e caratteri di scrittura.

File bitmap

- Formati .bmp, .tiff, .jpg o .gif
- Risoluzione minima 1:1. 1.200 dpi per linee e testi
- Risoluzione minima 1:1. 300 dpi per foto (CMYK) e loghi con retino

Stampati

- Formato 1:2
- Stampe laser con risoluzione minima di 600 dpi

Disegni tecnici

È possibile richiedere il disegno tecnico (.pdf, .eps) per tutti i prodotti, affinché il vostro grafico o la vostra agenzia possano creare il layout correttamente.

Progetti / Grafica

Se non disponete di un supporto grafico, potete rivolgervi a noi. I nostri grafici sapranno creare un prodotto su misura per voi sulla base delle vostre indicazioni. Vi chiediamo una descrizione scritta delle vostre idee, oltre a file digitali della miglior qualità possibile (vedi sopra).

Fattibilità

Colori DS, QS e DNA

Nel limite del fattibile stampiamo tutti i colori delle scale Pantone (colori "C"), HKS (colori "K") e RAL. Si prega di indicare sempre sul progetto di stampa quale colore (numero di riferimento in una delle scale cromatiche menzionate) è da utilizzarsi e per quale posizione. Stampiamo anche 5 colori fluo (giallo, verde, rosa, arancio, sunset orange) sulle superfici P02, M02 e B02.

Colori e dimensione dei caratteri / Astucci

I PS2, opzione rivestimento per PS4 vengono realizzati con la classica quadricromia. Questa tecnica è particolarmente adatta per la riproduzione di immagini e illustrazioni. Nel caso di richieste o desideri particolari vi preghiamo di contattarci per telefono o e-mail. Saremo lieti di potervi aiutare.

Dimensione dei caratteri DS, QS e DNA

I caratteri devono essere preferibilmente in traccati (PATH). Di norma raccomandiamo caratteri con dimensione a partire da 4 punti. La dimensione massima realizzabile dei caratteri dipende dall'area di stampa del rispettivo strumento di scrittura.

Spessore del tratto

Lo spessore minimo del tratto e la distanza fra le linee sono stabiliti dalla fattibilità a livello tecnico e dalla leggibilità:

- spessore del tratto: $\geq 0,1$ mm
- distanza fra le linee: $\geq 0,1$ mm

Incisione laser

Disponibile per le clip in metallo dei modelli DS8 e QS, e i moduli B della DNA Identity Pen.

Designer's choice

Quantità d'ordine minima di 5.000 penne secondo il listino prezzi standard. A queste condizioni disponibile solo nella configurazione scelta dal designer.

Approvazione alla stampa

Idoneità alla stampa

Dopo aver ricevuto il vostro progetto di stampa, vi inviamo una bozza via e-mail, in cui indichiamo chiaramente colori, posizioni e dimensione di stampa. Si prega di controllare tutte le indicazioni riportate. Se è tutto come vi siete proposti, attendiamo la vostra tempestiva approvazione. Solo a questo punto potremo iniziare la produzione.

Correzioni

Qualora desideriate apportare correzioni, vi preghiamo di comunicarle in modo dettagliato via email. Per l'approvazione definitiva riceverete una nuova bozza via e-mail con le modifiche apportate.

Ulteriori informazioni

Ordini

Si prega di utilizzare i codici di ordine completi e di precisare i dettagli desiderati, ad es. il colore dell'inchiostro. In questo modo ci aiutate ad evadere il vostro ordine nel modo più sollecito possibile.

Prodotti e prezzi

Il codice e il prezzo unitario per quantità dei nostri prodotti sono indicati nel nostro listino prezzi.

Condizioni di consegna e pagamento

Le nostre condizioni generali sono riportate nei nostri listini prezzi.

Spedizione

Tutti i nostri prodotti vengono confezionati in scatole contenenti 50/100 pezzi e successivamente in cartoni da 500/1.000 pz. I modelli DS2, DS3.1, DS4, DS5, DS7 e DS9 sono confezionati in scatole da 50 pezzi, mentre i modelli DS1, DS3, DS8, e QS sono confezionati in scatole da 100 pezzi ciascuna. In alternativa, i nostri prodotti possono essere confezionati in appositi imballaggi: PS2, PS4 & Polybag. La DNA Identity Pen è imballata singolarmente in una scatola trasparente di PET riciclato.

Ulteriore supporto per voi

Sebbene sia nostra intenzione rendere chiaramente accessibili tutte le informazioni, è possibile che il nostro catalogo non risponda a tutte le domande. Non esitate quindi a chiamarci, consultare il nostro sito Internet o a inviarci una e-mail, qualora qualcosa non fosse ancora ben chiaro.

Полезно знать

[rus]

Изображения

Чтобы персонализировать Ваши изделия серий DS, QS, DNA и PS в соответствии с Вашими представлениями, нам нужны Ваши образцы для печати. Наилучшие результаты и максимально быструю обработку гарантируют цифровые образцы. Мы также можем работать с фильмами и печатными образцами.

Векторные файлы

- Adobe Illustrator (.ai)
 - InDesign (.indd)
 - или форматы .eps или .pdf этих программ.
- Пожалуйста, не забудьте приложить к Вашей папке фото, рисунки и возможные специальные шрифты с соответствующими указаниями.

Файлы bitmap

- Форматы .bmp, .tiff, .jpg или .gif
- Минимальное разрешение 1:1: 1.200 dpi для линий и текстов
- Минимальное разрешение 1:1: 300 dpi для фотографий (СМΥК) и растровых логотипов

Пленки

- Формат 1:1
- На каждой пленке необходимо указать цвет.

Графические Материалы

- Формат 1:2
- Распечатка на лазерном принтере с минимальным разрешением 600 dpi

Выкройки

Для каждого продукта мы предоставим Вам соответствующий шаблон (в формате .eps или .pdf). Вашим художникам или Вашему агентству выкройки нужны для размещения на ней эскиза.

Предложения по оформлению / графика

Если у Вас нет дизайнера или агентства, Вы можете совершенно спокойно обратиться к нам. За определенный гонорар наши художники создадут изделие серии Вашей мечты. Наряду с коротким письменным описанием Ваших представлений нам необходимо иметь цифровой оригинал максимально высокого качества (см. сверху).

Возможности

Цвета DS, QS и DNA

В пределах технических возможностей мы можем печатать любым цветом по шкалам Pantone («С» цветов), HKS («К» цветов) и RAL. Пожалуйста, всегда указывайте каждый цвет в соответствии с номером одной из выбранных Вами вышперечисленных цветовых систем. Просим учесть также, что мы наносим изображение в 5 флуоресцент-ных цветах (желтый, зеленый, розовый, оранжевый и оранжевый закат) на поверхно-стях P02, M02 и B02.

Цвета / Упаковка

Нанесение на упаковки PS2 и PS4 производится с помощью полноцветной печати. При наличии особых требований или специальных пожеланий свяжитесь, пожалуйста, с нами по телефону, факсу или электронной почте. Мы будем рады оказать Вам помощь.

Размер Шрифта DS, QS и DNA

Как правило, мы рекомендуем использовать высоту букв от 4 пунктов. В сторону увеличения высота букв ограничивается соответствующей площади печати на пишущем приборе.

Толщина Штриха

Минимальная толщина штриха и расстояние между линиями определяется пределами технических возможностей и оптической восприимчивостью:

- толщина линий $\geq 0,1$ mm
- расстояние между линиями $\geq 0,1$ mm

Лазерная гравировка

Доступна металлического клипа DS8 Identity Pen и B- модуля модели DNA.

Designer's choice

Минимальная партия 5.000 письменных приборов по стандартному прайс-листу. На данных условиях поставка возможна только в выбранной дизайнером конфигурации.

Утверждение Макета-Оригинала

Печать Заказа

После получения от вас информации, необходимой для персонализации мы пошлем вам по электронной почте макет-оригинал, в котором указаны цвета, логотип, место размещения и размер наносимого изображения. Пожалуйста, тщательно проверьте всю эту информацию. Если вас все устраивает, пожалуйста, пришлите нам утвержденный макет. После этого заказ запускается в производство.

Исправления

Если Вы хотите внести изменения, пожалуйста, опишите их детально и пришлите по e-mail. Просим убедиться, что Ваши исправления будут нам понятны. После внесения изменений, мы опять пошлем Вам макет на утверждение.

Дополнительная Информация

Заказы

Пожалуйста, используйте полный код заказа и уточняйте все необходимые детали, например, цвет чернил (пасты). Этим Вы поможете нам выполнить Ваш заказ в кратчайшие сроки.

Изделия и Цены

Код заказа и цену за единицу продукции в зависимости от объема заказа можно найти в нашем прайс-листе. Условия Поставки и Оплаты. Наши общие условия заключения торговых сделок находятся в прайс-листе.

Отгрузка

Наши письменные приборы мы упаковываем в элегантные, изготовленные на заказ коробки по 50/100 шт и отгружаем в картонных коробках по 500/1000 шт. Модели DS1, DS3, DS8 и QS упакованы по 100 шт. Модели DS2, DS3.1, DS4, DS5, DS7 и DS9 поставляются в коробке по 50 шт. В дополнение к стандартной коробке, все наши модели могут поставляться в индивидуальной упаковке: PS2, PS4 и пластиковых пакетах. Модель DNA индивидуально упакована в прозрачную коробку.

Дальнейшая Помощь

Хотя мы прилагаем все усилия для того, чтобы обеспечить Вас всей необходимой информацией, возможно, что наш каталог не сможет ответить на какие-то Ваши вопросы. Позвоните нам, посетите нас в Интернете, пошлите нам сообщение по электронной почте или факсом, если Вы хотите еще что-то дополнительно узнать.

Special colours

[eng]

Special colours

In the unlikely event that the colour you're looking for is not part of our standard range, we look forward to mixing it for you – with Pantone, HKS and RAL colour scales.

DS3 Biotic: the result is matched to your Pantone colour as closely as technically possible.

[deu]

Sonderfarben

Sollten Sie unter unseren vielen Standardfarben wider Erwarten nicht die Farbe Ihrer Wahl finden, mischen wir sie natürlich gerne für Sie – nach den Skalen Pantone, HKS und RAL.

DS3 Biotic: das Ergebnis ist Ihrer Pantone-Farbe so nah wie technisch möglich.

[fra]

Couleurs spéciales

Si, par malchance, vous ne parvenez pas à trouver la couleur que vous souhaitez dans la palette de notre gamme de couleurs standards, nous nous ferons un plaisir de la réaliser pour vous, selon les références Pantone, HKS et RAL.

DS3 Biotic: le résultat sera aussi proche de votre couleur Pantone que la technologie le permet.

[esp]

Colores especiales

Si se da la desafortunada circunstancia de que, pese a la amplitud de nuestra gama de colores estándar, usted no encuentra el color que busca, estaremos encantados de crearlo a su medida tomando como referencia las gamas cromáticas Pantone, HKS y RAL.

DS3 Biotic: el resultado se ajustará a su color Pantone tanto como sea posible técnicamente.

[ita]

Colori speciali

Se per uno sfortunato caso non riusciste a trovare il colore che cercate all'interno del nostro vasto assortimento, saremo lieti di crearlo su misura per voi utilizzando le gamme cromatiche Pantone, HKS e RAL.

DS3 Biotic: il risultato, nei limiti tecnici, si avvicinerà il più possibile al colore Pantone da voi scelto.

[rus]

Специальные цвета

Если же по какой-либо случайности вы не сможете найти нужный вам цвет в нашем большом ассортименте, мы с радостью создадим его специально для вас, используя цветовые системы Pantone, RAL и HKS.

DS3 Biotic: Результат соответствует цвету шкалы Pantone настолько, насколько это возможно технически.



Mix & Match

[eng]

How does it work?

You can Mix & Match the colours as long as you keep the given mix of surfaces. For technical reasons Mix & Match is not possible for varnished, Soft touch, biotic and regenerated surfaces. Not applicable for DNA Identity Pen.

[deu]

Wie funktioniert das?

Farben können kombiniert werden, solange die vorgegebene Oberfläche beibehalten wird. Aus technischen Gründen ist Mix & Match für lackierte Oberflächen sowie Modelle in Soft touch, biotic und regenerated nicht möglich. Ausnahme ist der DNA Identity Pen.

[fra]

Qu'est-ce que c'est ?

Tant que vous conservez l'association initiale des surfaces, vous pouvez procéder à un Mix & Match de couleurs. Pour des raisons techniques, Mix & Match est impossible avec les surfaces laquées, Soft touch, biotic et regenerated. Ne s'applique pas au DNA Identity Pen.

[esp]

¿Cómo funciona esto?

Puedes mezclar y combinar con Mix & Match los colores siempre y cuando conserves el mix de superficies establecido. Por razones técnicas el Mix & Match no está disponible en superficies barnizadas, Soft touch, biotic y regenerated. No aplicable para DNA Identity Pen.

[ita]

Come funziona?

Tramite Mix & Match possono essere combinati i colori purché rimanga invariato il mix di superfici stabilito. Per motivi tecnici il Mix & Match non è disponibile per superfici verniciate, Soft touch, biotic e regenerated. Non applicabile a DNA Identity Pen.

[rus]

Как это работает?

Вы можете смешивать и сочетать цвета, пока сохраняется первоначально выбранное сочетание поверхностей. По техническим причинам Смешивание и Сочетание невозможно для глянцевых поверхностей, поверхностей софт-тач и биотик.

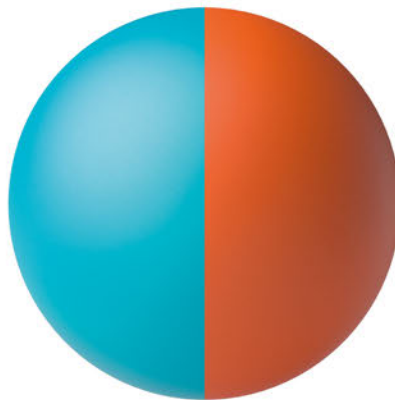
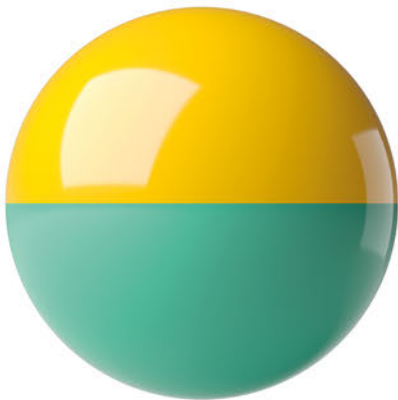

[eng]

This time you can't wait?

No problem! In just 5 working days after your approval we will ship 500 to 5.000 personalized pens with your message printed in up to 5 colours on the clip.

[deu]

Sie haben es eilig?

Kein Problem. Nur 5 Tage nach Druckfreigabe gehen 500 – 5'000 personalisierte Schreibgeräte mit einem in bis zu 5 Farben bedruckten Clip an Sie raus.

[fra]

Vous n'avez le temps d'attendre?

En 5 jours seulement après votre validation, nous sommes en mesure de expédier entre 500 et 5.000 stylos personnalisés, avec votre message imprimé jusqu'à 5 couleurs sur le clip.

[esp]

No puedes esperar esta vez?

¡No hay problema! En solo 5 días laborables después confirmación, le enviaremos de 500 hasta 5.000 bolígrafos personalizados con su mensaje imprimido en hasta 5 colores en el clip.

[ita]

Non avete tempo di aspettare?

In soli 5 giorni dall'approvazione dell'ordine possiamo spedire da 500 a 5.000 penne con il vostro messaggio personalizzato, utilizzando fino a 5 colori, posizionato su clip.

[rus]

Ты не можешь ждать?

Нет проблем! Всего через 5 рабочих дней после вашего подтверждения, мы отправим от 500 до 5.000 ручек с вашим полноцветным нанесением на клипе.

DS3

DS5

DS8

Body

Frosted



Transparent



Polished



Regenerated



Metal nose cone

(Not available for frosted and regenerated surface)

Chrome finish metal



Print area

Clip
40 × 8 mm (1,57 × 0,31 inch) 5 colours

Refill



Floating Ball® 1.0 lead free, blue ink

Body

Frosted



Transparent



Matt



Metal nose cone

(Only available for transparent surface)

Chrome finish metal



Print area

Clip
40 × 7 mm (1,57 × 0,28 inch) 5 colours

Body

Polished



Soft touch



Metal button

Satin finish metal



Chrome finish metal



Print area

Clip
36 × 7 mm (1,41 × 0,28 inch) 5 colours

Colour and surface table

T01	F01	P02	M02	B02	Q02	B04	M05	M07	P07	R07	P06	F06	T06	M06	R06	Q13	
DS1 DS2 DS3 DS3.1 DS5 DS7	DS1 DS2 DS3 DS3.1 DS5 DS7	DS1 DS2 DS3 DS3.1 DS5 DS7 DS8	QS01 QS20 QS30 QS40 DS1 DS2 DS3 DS4 DS5 DS7 DS8 DS9	DS3	QS01 QS20 QS30	DS3	DS9	QS01 QS20 QS30 QS40 DS8	DS3.1	QS01 QS20 QS30 QS40	DS1 DS3 DS5	DS1 DS3 DS5 DS7	DS3 DS5 DS7	DS4	DS4	QS01 QS20 QS30	
Q14	M10	R10	B10	P10	F10	T10	M13	N94	M20	R20	Q20	P20	F20	T20	R21	B21	
QS01 QS20 QS30	QS01 QS20 QS30 QS40 DS4	QS01 QS20 QS30 QS40	DS3	DS1 DS2 DS3 DS5 DS7 DS8	DS2 DS3 DS5 DS7	DS1 DS2 DS3 DS3.1 DS5 DS7	DS9	DS3 DS5 DS8	QS01 QS20 QS30 QS40 DS2 DS3 DS4 DS5 DS9	QS01 QS20 QS30 QS40	QS01 QS20 QS30	QS01 QS20 QS30	DS2 DS3 DS3.1 DS5 DS7 DS8	DS1 DS2 DS3	DS1 DS2 DS3	DS3 DS8	DS3
F21	T21	F26	T26	F25	T25	M23	M27	R28	F30	T30	P31	T59	F59	F50	T50	R50	
DS5 DS7	DS5 DS7	DS3.1	DS3.1	DS3	DS3 DS3.1	DS1 DS9	DS8 DS9	DS8	DS3 DS5 DS7	DS3 DS3.1 DS5 DS7	DS3.1	DS3.1	DS3.1	DS1 DS2 DS3 DS5 DS7	DS1 DS2 DS3 DS5 DS7	DS3 DS8	
P52	M52	P55	N92	M62	R62	Q62	F55	T55	B52	M61	M54	R54	P53	T51	F51	T53	
DS1 DS2 DS3 DS5	DS3 DS5	DS8	DS3 DS5 DS8	QS01 QS20 QS30 QS40 DS4	QS01 QS20 QS30 QS40 DS4 DS8	QS01 QS20 QS30	DS1 DS2 DS3	DS1 DS2 DS3 DS3.1	DS3	DS2 DS9	DS4	DS4 DS8	DS7	DS5 DS7	DS5 DS7	DS3.1	

New surface and colours!

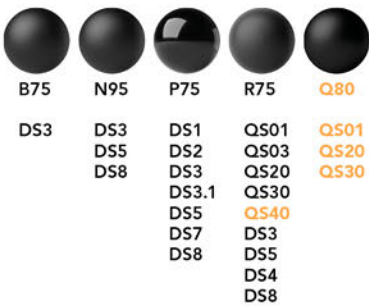
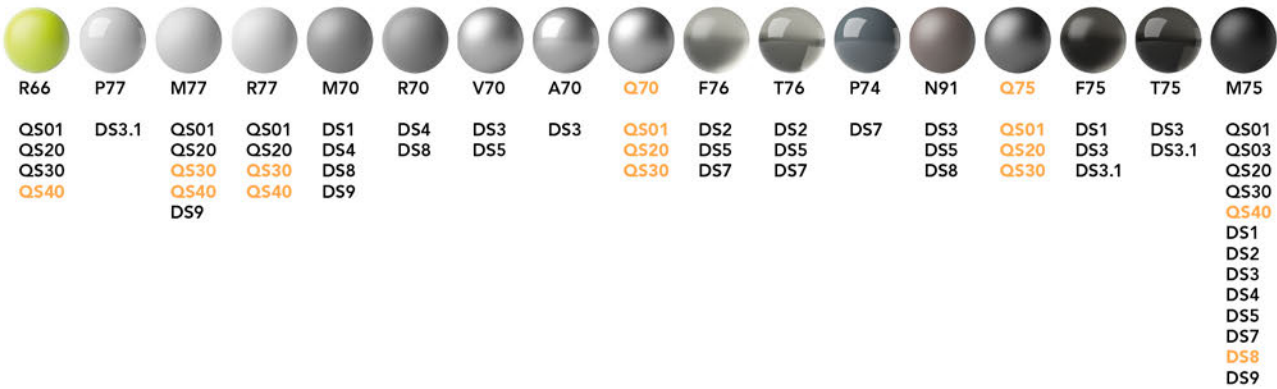
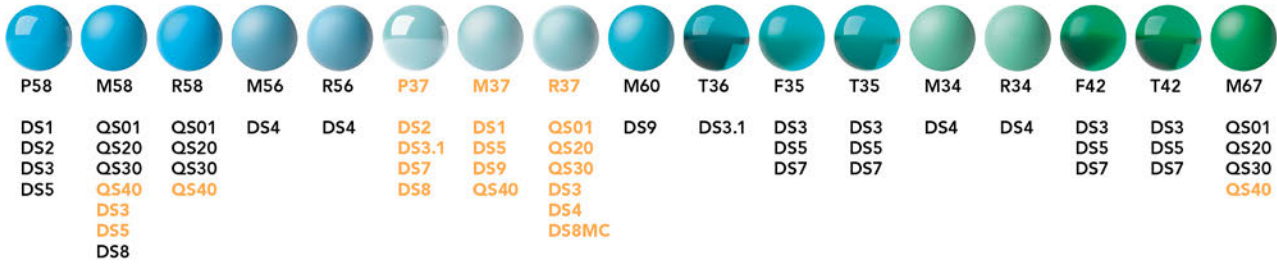

- F Frosted
- T Transparent
- M Matt
- P Polished
- V Varnished matt
- A Varnished polished
- R Soft touch
- B Biotic
- N Regenerated
- Q Stone

© 2020 Pagani Pens SA

Prodir
Via Serta 22
CH-6814 Lamone
Switzerland
www.prodir.com

Concept
and graphic design
Studio CCRZ
Copy
Marketing Prodir
CGI
Studio 9010
RNR Studio (152-159)
Print
Nava Press









